

Harvey Cement Products, Inc.

Since 1947

16030 Park Avenue, Harvey, IL 60426

Ph: 708.333.1900 F: 708.333.1910

www.harveycement.com

SavannaStone[®] Profiles

Stock Molds – Currently Available

TABLE OF CONTENTS

RECTANGULAR – SMOOTH PROFILES

RECTANGULAR PROFILES FOR FIELD, BANDS, OR COPING 3

RECTANGULAR – TEXTURED PROFILES

ROCKFACE AND SLATE 35

CHAMFERED PROFILES

CHAMFERED PROFILES FOR SILLS, BANDS, TRANSITION BANDS 41

SILLS

SILLS – SINGLE PITCH WITH NO FLAT 83

SINGLE PITCH COPING

SINGLE PITCH COPING 91

DOUBLE PITCH COPING

DOUBLE PITCH COPING 105

CHAMFERED COPING

FLAT COPING WITH CHAMFERED EDGES 115

CORNICES

CORNICE PROFILES 121

SPECIALTY PROFILES

CAPS, STEPPED BANDS, ETC. 131

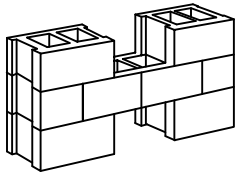

Harvey Cement Products, Inc.

Since 1947

16030 Park Avenue, Harvey, IL 60426

Ph: 708.333.1900 F: 708.333.1910

www.harveycement.com

ALL RECTANGULAR PROFILES CAN BE USED AS BANDS, FIELD, HEADERS, OR TURNED FOR COPING.

	W	H	ID
	2 1/4"	7 5/8"	GW
	2 1/4"	19"	DJ
	3 1/4"	6"	GZ
	3 5/8"	1 5/8"	Q
	3 5/8"	2 3/8"	CA
	3 5/8"	3 5/8"	E
	3 5/8"	5 5/8"	V
	3 5/8"	7 5/8"	Z
	3 5/8"	11 5/8"	F
	3 5/8"	15 5/8"	C
	3 5/8"	17"	DN
	3 5/8"	23 5/8"	W
	4 1/8"	4 1/2"	HG
	4 3/8"	7 5/8"	CE
	4 1/2"	24"	DE
	4 5/8"	3 5/8"	DM
	4 5/8"	6 5/8"	EV
	4 5/8"	7 5/8"	JB
	4 5/8"	9 5/8"	GM
	4 5/8"	11 5/8"	AY
	4 5/8"	15 5/8"	EN
	5 1/8"	4"	HJ
	5 5/8"	5"	EP
	5 5/8"	5 5/8"	EJ

PROFILE TYPE:

RECTANGULAR

SURFACE FINISH:

SMOOTH

REFER TO
INDIVIDUAL
PROFILE (ID) PAGES
FOR DETAILS
AND LENGTHS
AVAILABLE.

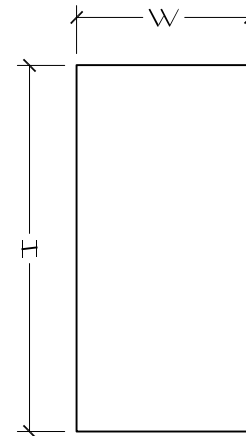

	W	H	ID
	5 5/8"	9"	ER
	5 5/8"	11"	EQ
	5 5/8"	12"	EW
	5 5/8"	15 5/8"	GL
	5 5/8"	20 5/8"	GK
	5 3/4"	8"	EL
	7 5/8"	5 3/8"	AZ

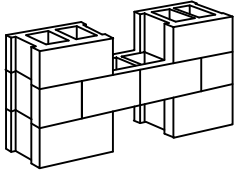

Harvey Cement Products, Inc.

Since 1947

16030 Park Avenue, Harvey, IL 60426

Ph: 708.333.1900 F: 708.333.1910

www.harveycement.com

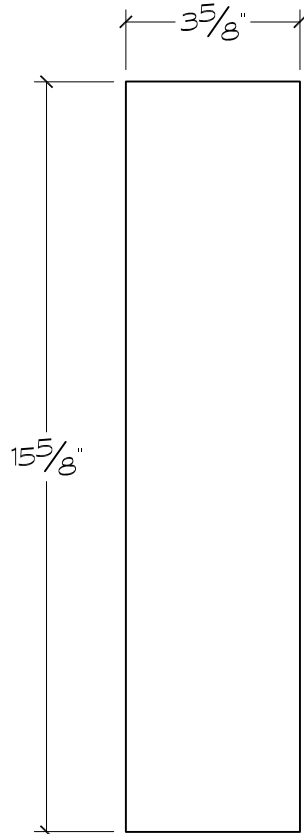

CROSS SECTION

① **PROFILE C**
 ARCH REF:
 SCALE: 3"=1'-0"

Profile ID

C

SUGGESTED USE

Sill	
Transition Band	
Coping	X
Cap	
Field / Band	X
Cornice	
Header	X

TYPE / SIZE
 AVAILABILITY

TYPE	LENGTH(S)
Straight	23 5/8" or 47 5/8"

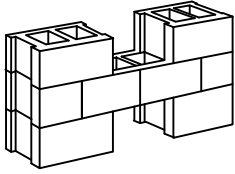

Harvey Cement Products, Inc.

Since 1947

16030 Park Avenue, Harvey, IL 60426

Ph: 708.333.1900 F: 708.333.1910

www.harveycement.com

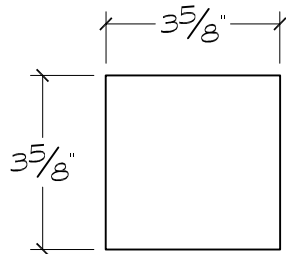

CROSS SECTION

1

PROFILE E

ARCH REF:
SCALE: 3"=1'-0"

Profile ID

E

SUGGESTED USE

Sill	
Transition Band	
Coping	
Cap	
Band	X
Cornice	

**TYPE / SIZE
AVAILABILITY**

TYPE	LENGTH(S)
Straight	23 5/8"
Straight	30"

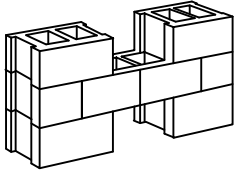

Harvey Cement Products, Inc.

Since 1947

16030 Park Avenue, Harvey, IL 60426

Ph: 708.333.1900 F: 708.333.1910

www.harveycement.com

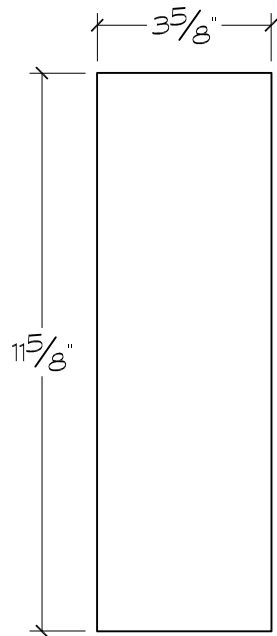

CROSS SECTION

1

PROFILE F

ARCH REF:
SCALE: 3"=1'-0"

Profile ID

F

SUGGESTED USE

Sill	
Transition Band	
Coping	X
Cap	
Field / Band	X
Cornice	
Header	X

**TYPE / SIZE
AVAILABILITY**

TYPE	LENGTH(S)
Straight	23 5/8"

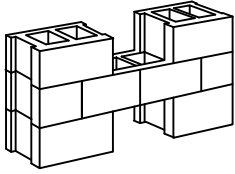

Harvey Cement Products, Inc.

Since 1947

16030 Park Avenue, Harvey, IL 60426

Ph: 708.333.1900 F: 708.333.1910

www.harveycement.com

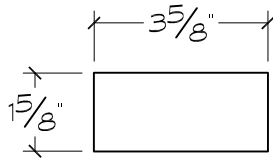

CROSS SECTION

① **PROFILE Q**

ARCH REF:
SCALE: 3"=1'-0"

Profile ID

Q

SUGGESTED USE

Sill	
Transition Band	
Coping	
Cap	
Band	X
Cornice	

**TYPE / SIZE
AVAILABILITY**

TYPE	LENGTH(S)
Straight	23 5/8"

DRIP EDGE - OPTIONAL

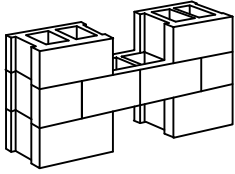

Harvey Cement Products, Inc.

Since 1947

16030 Park Avenue, Harvey, IL 60426

Ph: 708.333.1900 F: 708.333.1910

www.harveycement.com

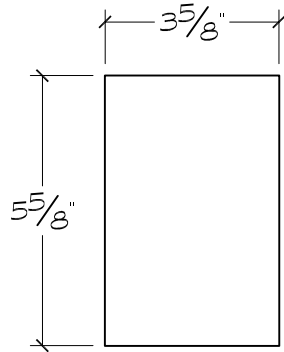

CROSS SECTION

① **PROFILE V**
 ARCH REF:
 SCALE: 3"=1'-0"

Profile ID

V

SUGGESTED USE

Sill	
Transition Band	
Coping	
Cap	
Band	X
Cornice	
Header	X

**TYPE / SIZE
 AVAILABILITY**

TYPE	LENGTH(S)
Straight	23 5/8"

DRIP EDGE - OPTIONAL

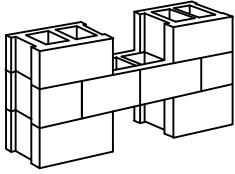

Harvey Cement Products, Inc.

Since 1947

16030 Park Avenue, Harvey, IL 60426

Ph: 708.333.1900 F: 708.333.1910

www.harveycement.com

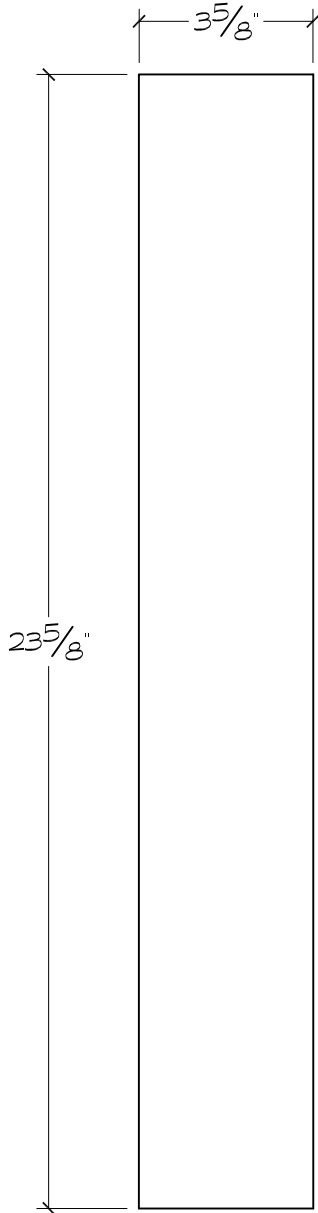

CROSS SECTION

1 **PROFILE W**
 ARCH REF:
 SCALE: 3"=1'-0"

Profile ID

W

SUGGESTED USE

Sill	
Transition Band	
Coping	X
Cap	
Field / Band	X
Cornice	

TYPE / SIZE
 AVAILABILITY

TYPE	LENGTH(S)
Straight	23 5/8"

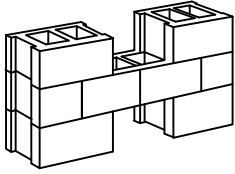

Harvey Cement Products, Inc.

Since 1947

16030 Park Avenue, Harvey, IL 60426

Ph: 708.333.1900 F: 708.333.1910

www.harveycement.com

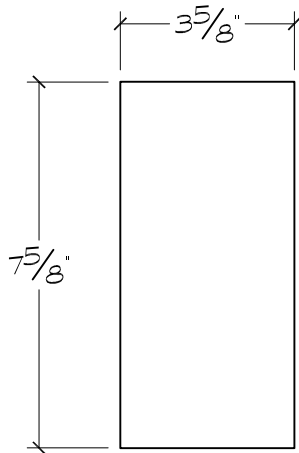

CROSS SECTION

① **PROFILE Z**
 ARCH REF:
 SCALE: 3"=1'-0"

Profile ID

Z

SUGGESTED USE

Sill	
Transition Band	
Coping	X
Cap	
Field / Band	X
Cornice	
Header	X

**TYPE / SIZE
 AVAILABILITY**

TYPE	LENGTH(S)
Straight	23 $\frac{5}{8}''$

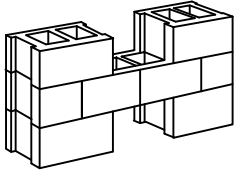

Harvey Cement Products, Inc.

Since 1947

16030 Park Avenue, Harvey, IL 60426

Ph: 708.333.1900 F: 708.333.1910

www.harveycement.com

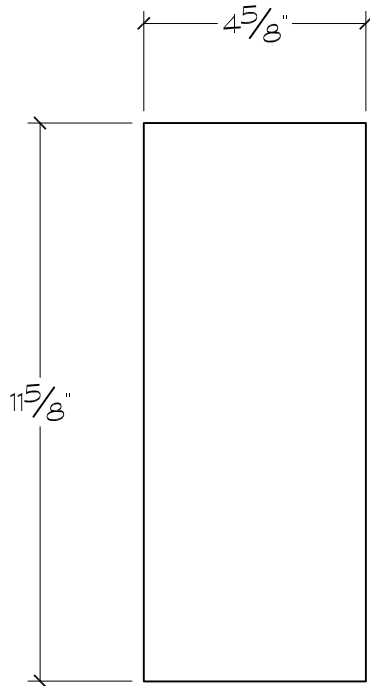

CROSS SECTION

① **PROFILE AY**
 ARCH REF:
 SCALE: 3"=1'-0"

Profile ID

AY

SUGGESTED USE

Sill	
Transition Band	
Coping	X
Cap	
Field / Band	X
Cornice	
Header	X

**TYPE / SIZE
 AVAILABILITY**

TYPE	LENGTH(S)
Straight	23 5/8"

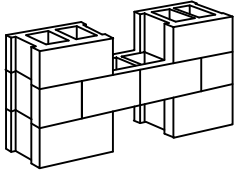

Harvey Cement Products, Inc.

Since 1947

16030 Park Avenue, Harvey, IL 60426

Ph: 708.333.1900 F: 708.333.1910

www.harveycement.com

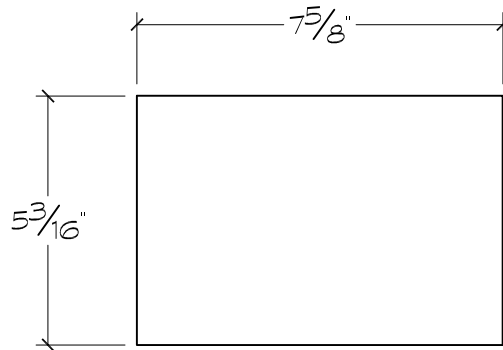

CROSS SECTION

1 **PROFILE AZ**
 ARCH REF:
 SCALE: 3"=1'-0"

DRIP EDGE - OPTIONAL

Profile ID

AZ

SUGGESTED USE

Sill	
Transition Band	
Coping	
Cap	
Band	X
Cornice	

**TYPE / SIZE
 AVAILABILITY**

TYPE	LENGTH(S)
Straight	23 5/8"

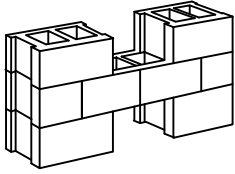

Harvey Cement Products, Inc.

Since 1947

16030 Park Avenue, Harvey, IL 60426

Ph: 708.333.1900 F: 708.333.1910

www.harveycement.com

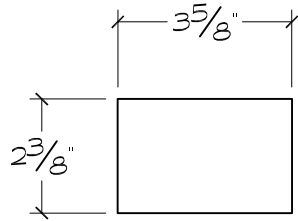

CROSS SECTION

① **PROFILE CA**
 ARCH REF:
 SCALE: 3"=1'-0"

Profile ID

CA

SUGGESTED USE

Sill	
Transition Band	
Coping	
Cap	
Band	X
Cornice	

TYPE / SIZE
AVAILABILITY

TYPE	LENGTH(S)
Straight	23 5/8"
Left End Return	
Right End Return	

DRIP EDGE - OPTIONAL

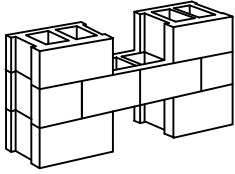

Harvey Cement Products, Inc.

Since 1947

16030 Park Avenue, Harvey, IL 60426

Ph: 708.333.1900 F: 708.333.1910

www.harveycement.com

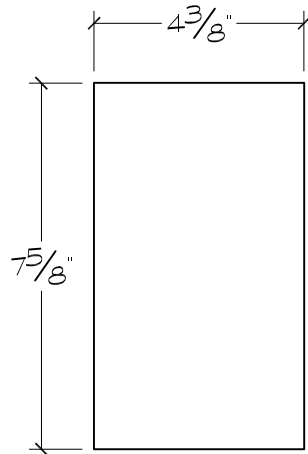

CROSS SECTION

1 **PROFILE CE**
 ARCH REF:
 SCALE: 3"=1'-0"

Profile ID

CE

SUGGESTED USE

Sill	
Transition Band	
Coping	
Cap	
Band	X
Cornice	
Header	X

TYPE / SIZE
 AVAILABILITY

TYPE	LENGTH(S)
Straight	23 5/8"

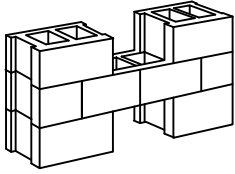

Harvey Cement Products, Inc.

Since 1947

16030 Park Avenue, Harvey, IL 60426

Ph: 708.333.1900 F: 708.333.1910

www.harveycement.com

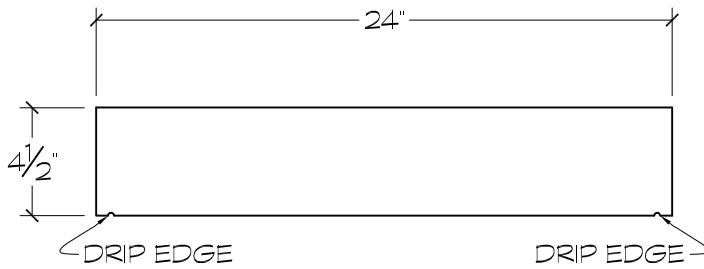

CROSS SECTION

① **PROFILE DE**

ARCH REF:
SCALE: 1-1/2"=1'-0"

Profile ID

DE

SUGGESTED USE

Sill	
Transition Band	
Coping	X
Cap	
Field / Band	
Cornice	

TYPE / SIZE AVAILABILITY

TYPE	LENGTH(S)
Straight	Up to 47 5/8"

DRIP EDGE - OPTIONAL

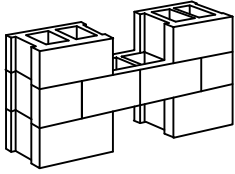

Harvey Cement Products, Inc.

Since 1947

16030 Park Avenue, Harvey, IL 60426

Ph: 708.333.1900 F: 708.333.1910

www.harveycement.com

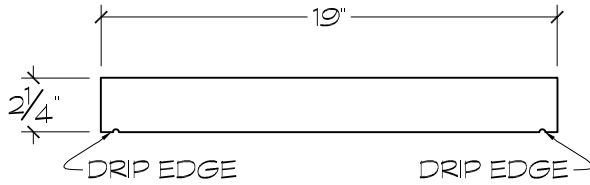

CROSS SECTION

1 **PROFILE DJ**
 ARCH REF:
 SCALE: 1-1/2"=1'-0"

Profile ID

DJ

SUGGESTED USE

Sill	
Transition Band	
Coping	X
Cap	
Field / Band	
Cornice	

TYPE / SIZE
 AVAILABILITY

TYPE	LENGTH(S)
Straight	Up to 33"

DRIP EDGE - OPTIONAL

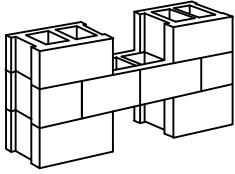

Harvey Cement Products, Inc.

Since 1947

16030 Park Avenue, Harvey, IL 60426

Ph: 708.333.1900 F: 708.333.1910

www.harveycement.com

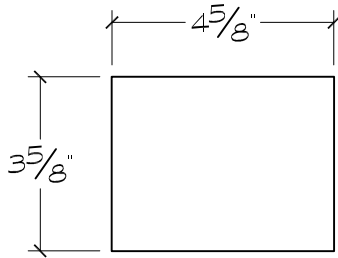

CROSS SECTION

1

PROFILE DM

ARCH REF:

SCALE: 3"=1'-0"

Profile ID

DM

SUGGESTED USE

Sill	
Transition Band	
Coping	
Cap	
Band	X
Cornice	

TYPE / SIZE
AVAILABILITY

TYPE	LENGTH(S)
Straight	23 5/8"

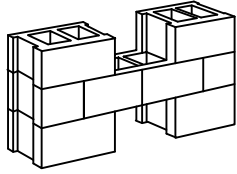

Harvey Cement Products, Inc.

Since 1947

16030 Park Avenue, Harvey, IL 60426

Ph: 708.333.1900 F: 708.333.1910

www.harveycement.com

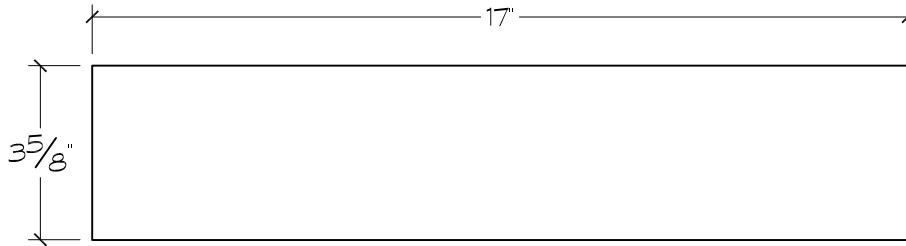

CROSS SECTION

1

PROFILE DN

ARCH REF:

SCALE: 3"=1'-0"

Profile ID

DN

SUGGESTED USE

Sill	
Transition Band	
Coping	X
Cap	
Field / Band	
Cornice	

TYPE / SIZE
AVAILABILITY

TYPE	LENGTH(S)
Straight	23 5/8"

DRIP EDGE - OPTIONAL

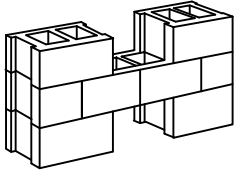

Harvey Cement Products, Inc.

Since 1947

16030 Park Avenue, Harvey, IL 60426

Ph: 708.333.1900 F: 708.333.1910

www.harveycement.com

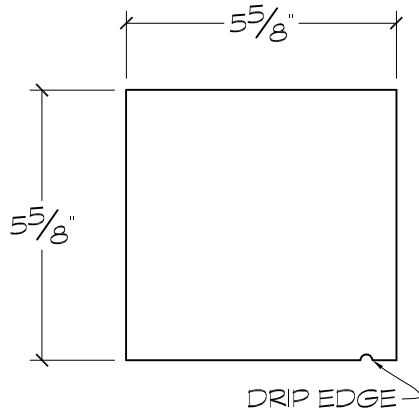

CROSS SECTION

1 **PROFILE EJ**
 ARCH REF:
 SCALE: 3"=1'-0"

Profile ID

EJ

SUGGESTED USE

Sill	
Transition Band	
Coping	
Cap	
Band	X
Cornice	

TYPE / SIZE AVAILABILITY

TYPE	LENGTH(S)
Straight	23 5/8"

DRIP EDGE - OPTIONAL

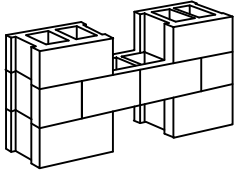

Harvey Cement Products, Inc.

Since 1947

16030 Park Avenue, Harvey, IL 60426

Ph: 708.333.1900 F: 708.333.1910

www.harveycement.com

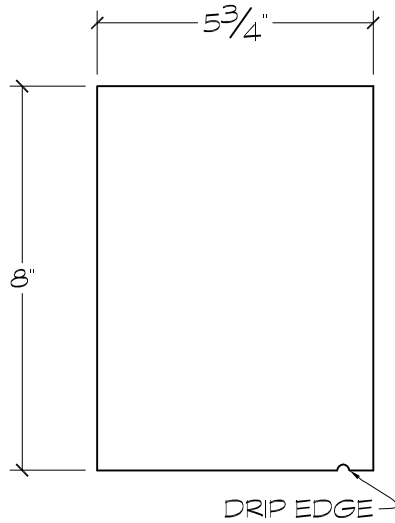

CROSS SECTION

1 **PROFILE EL**
 ARCH REF:
 SCALE: 3"=1'-0"

Profile ID

EL

SUGGESTED USE

Sill	
Transition Band	
Coping	
Cap	
Band	X
Cornice	
Header	X

TYPE / SIZE AVAILABILITY

TYPE	LENGTH(S)
Straight	23 5/8"

DRIP EDGE - OPTIONAL

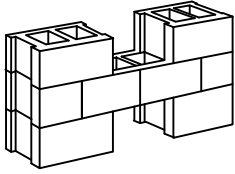

Harvey Cement Products, Inc.

Since 1947

16030 Park Avenue, Harvey, IL 60426

Ph: 708.333.1900 F: 708.333.1910

www.harveycement.com

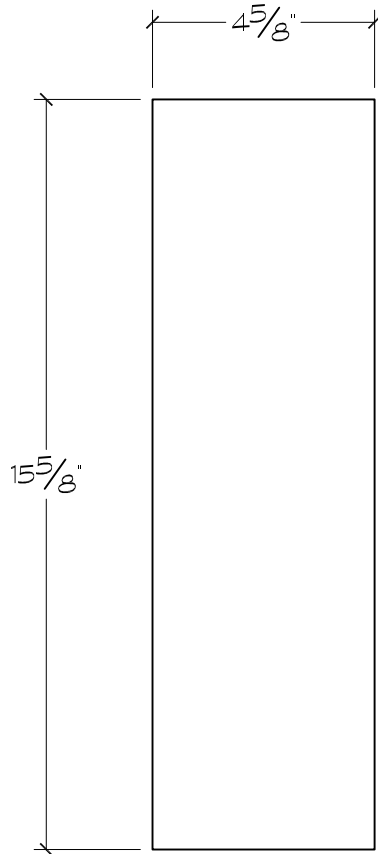

CROSS SECTION



PROFILE EN

ARCH REF:
SCALE: 3"=1'-0"

Profile ID

EN

SUGGESTED USE

Sill	
Transition Band	
Coping	X
Cap	
Field / Band	X
Cornice	
Header	X

**TYPE / SIZE
AVAILABILITY**

TYPE	LENGTH(S)
Straight	23 $\frac{5}{8}$ " or 47 $\frac{5}{8}$ "

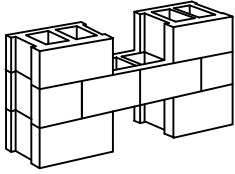

Harvey Cement Products, Inc.

Since 1947

16030 Park Avenue, Harvey, IL 60426

Ph: 708.333.1900 F: 708.333.1910

www.harveycement.com

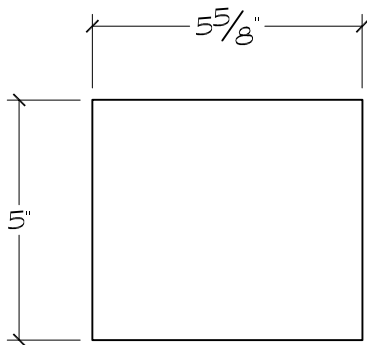

CROSS SECTION

① **PROFILE EP**
 ARCH REF:
 SCALE: 3"=1'-0"

Profile ID

EP

SUGGESTED USE

Sill	
Transition Band	
Coping	
Cap	
Band	X
Cornice	

TYPE / SIZE
 AVAILABILITY

TYPE	LENGTH(S)
Straight	23 5/8"

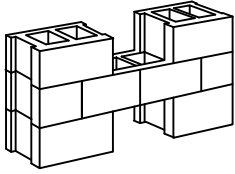

Harvey Cement Products, Inc.

Since 1947

16030 Park Avenue, Harvey, IL 60426

Ph: 708.333.1900 F: 708.333.1910

www.harveycement.com

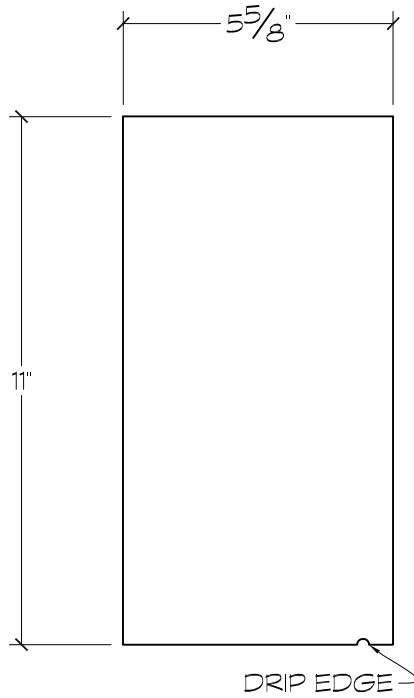

CROSS SECTION

1 PROFILE EQ

ARCH REF:
SCALE: 3"=1'-0"

DRIP EDGE - OPTIONAL

Profile ID

EQ

SUGGESTED USE

Sill	
Transition Band	
Coping	X
Cap	
Band	X
Cornice	
Header	X

TYPE / SIZE
AVAILABILITY

TYPE	LENGTH(S)
Straight	35 5/8"

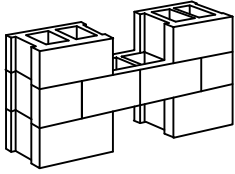

Harvey Cement Products, Inc.

Since 1947

16030 Park Avenue, Harvey, IL 60426

Ph: 708.333.1900 F: 708.333.1910

www.harveycement.com

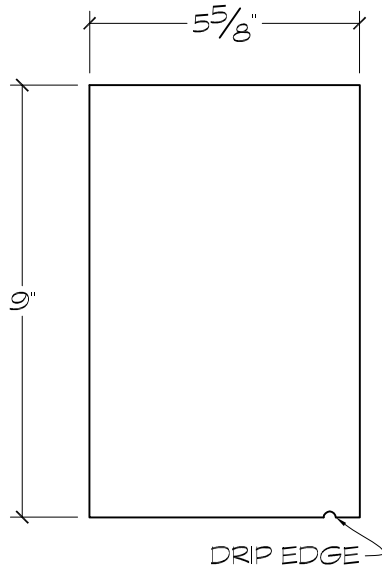

CROSS SECTION

1

PROFILE ER

ARCH REF:

SCALE: 3"=1'-0"

Profile ID

ER

SUGGESTED USE

Sill	
Transition Band	
Coping	
Cap	
Band	X
Cornice	
Header	X

**TYPE / SIZE
AVAILABILITY**

TYPE	LENGTH(S)
Straight	23 5/8"

DRIP EDGE - OPTIONAL

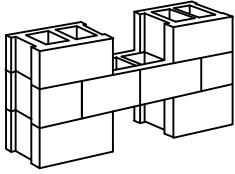

Harvey Cement Products, Inc.

Since 1947

16030 Park Avenue, Harvey, IL 60426

Ph: 708.333.1900 F: 708.333.1910

www.harveycement.com

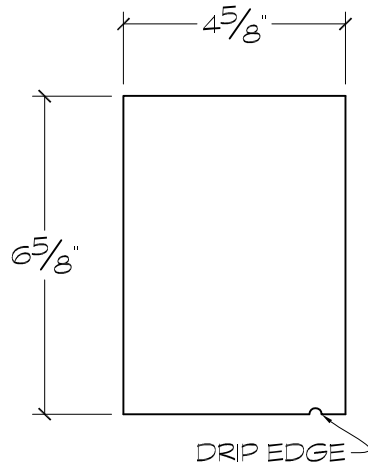

CROSS SECTION

1 **PROFILE EV**
 ARCH REF:
 SCALE: 3"=1'-0"

Profile ID

EV

SUGGESTED USE

Sill	
Transition Band	
Coping	
Cap	
Band	X
Cornice	
Header	X

TYPE / SIZE
 AVAILABILITY

TYPE	LENGTH(S)
Straight	23 5/8"

DRIP EDGE - OPTIONAL

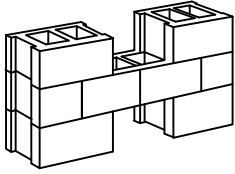

Harvey Cement Products, Inc.

Since 1947

16030 Park Avenue, Harvey, IL 60426

Ph: 708.333.1900 F: 708.333.1910

www.harveycement.com

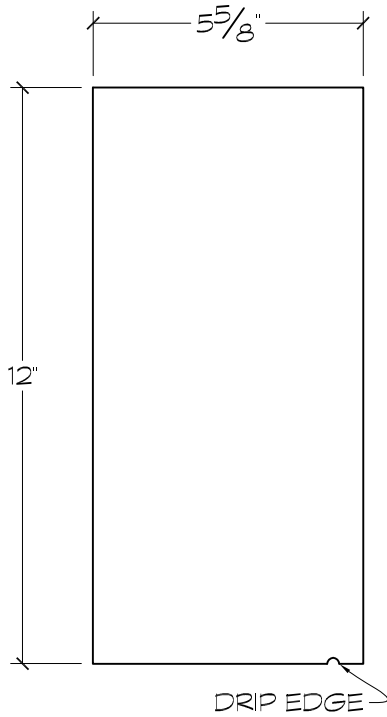

CROSS SECTION

① **PROFILE EW**

ARCH REF:
SCALE: 3"=1'-0"

Profile ID

EW

SUGGESTED USE

Sill	
Transition Band	
Coping	X
Cap	
Band	X
Cornice	
header	X

**TYPE / SIZE
AVAILABILITY**

TYPE	LENGTH(S)
Straight	23 5/8"

DRIP EDGE - OPTIONAL

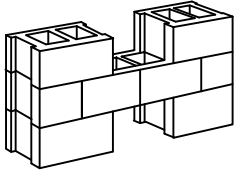

Harvey Cement Products, Inc.

Since 1947

16030 Park Avenue, Harvey, IL 60426

Ph: 708.333.1900 F: 708.333.1910

www.harveycement.com

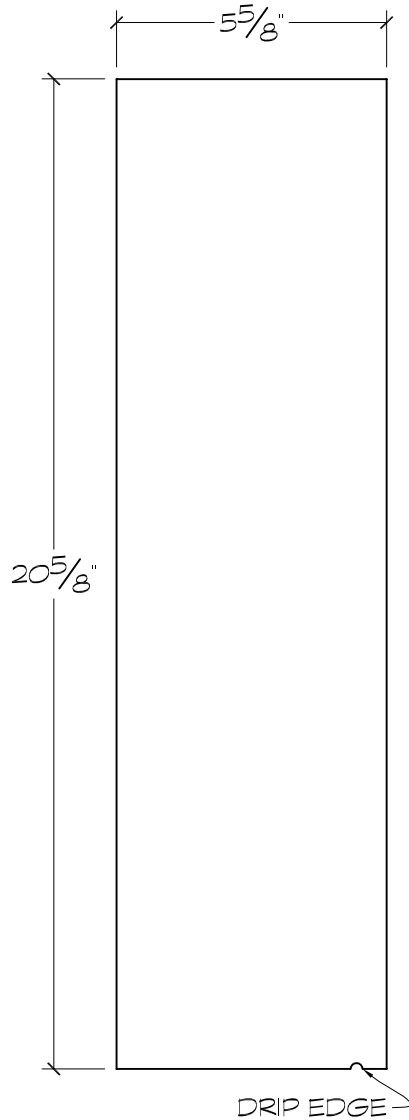

CROSS SECTION

1 **PROFILE GK**
 ARCH REF:
 SCALE: 3"=1'-0"

DRIP EDGE - OPTIONAL

Profile ID

GK

SUGGESTED USE

Sill	
Transition Band	
Coping	X
Cap	
Band	X
Cornice	

TYPE / SIZE AVAILABILITY

TYPE	LENGTH(S)
Straight	35 5/8"

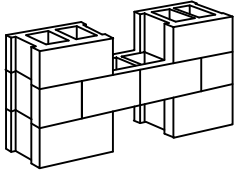

Harvey Cement Products, Inc.

Since 1947

16030 Park Avenue, Harvey, IL 60426

Ph: 708.333.1900 F: 708.333.1910

www.harveycement.com

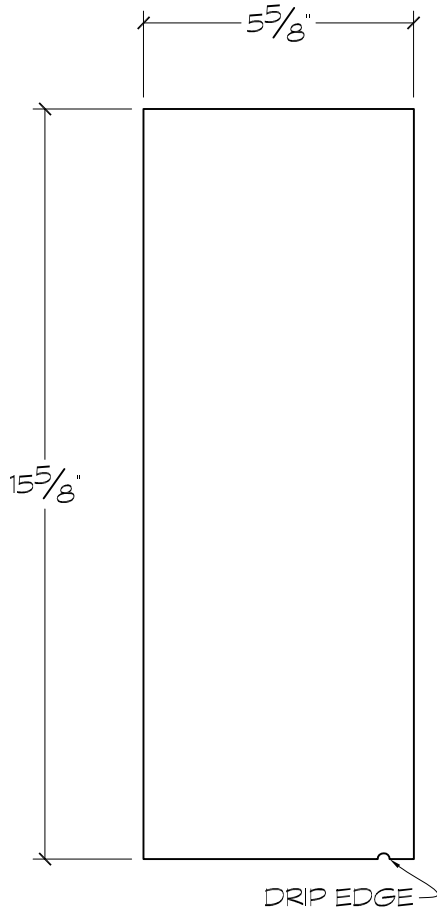

CROSS SECTION

① **PROFILE GL**
 ARCH REF:
 SCALE: 3"=1'-0"

DRIP EDGE - OPTIONAL

Profile ID

GL

SUGGESTED USE

Sill	
Transition Band	
Coping	
Cap	
Band	X
Cornice	
Header	X

**TYPE / SIZE
 AVAILABILITY**

TYPE	LENGTH(S)
Straight	35 5/8"

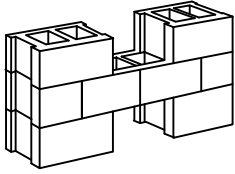

Harvey Cement Products, Inc.

Since 1947

16030 Park Avenue, Harvey, IL 60426

Ph: 708.333.1900 F: 708.333.1910

www.harveycement.com

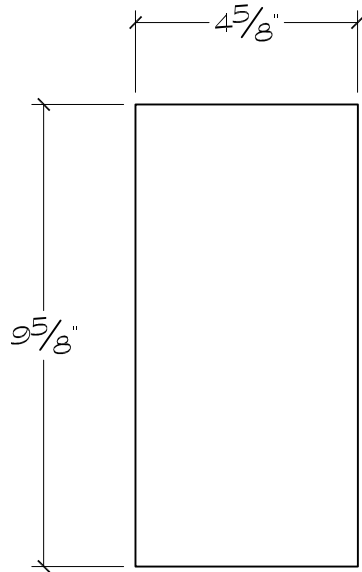

CROSS SECTION

1

PROFILE GM

ARCH REF:

SCALE: 3"=1'-0"

Profile ID

GM

SUGGESTED USE

Sill	
Transition Band	
Coping	X
Cap	
Band	X
Cornice	
Header	X

**TYPE / SIZE
AVAILABILITY**

TYPE	LENGTH(S)
Straight	35 5/8"

DRIP EDGE - OPTIONAL

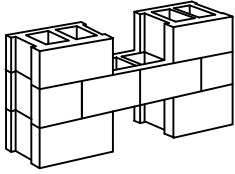

Harvey Cement Products, Inc.

Since 1947

16030 Park Avenue, Harvey, IL 60426

Ph: 708.333.1900 F: 708.333.1910

www.harveycement.com

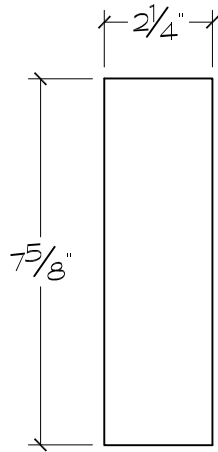

CROSS SECTION

1

PROFILE GW

ARCH REF:
SCALE: 3"=1'-0"

Profile ID

GW

SUGGESTED USE

Sill	
Transition Band	
Coping	X
Cap	
Field / Band	X
Cornice	

TYPE / SIZE AVAILABILITY

TYPE	LENGTH(S)
Straight	23 5/8"

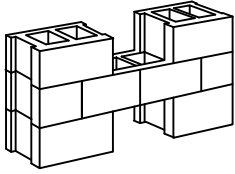

Harvey Cement Products, Inc.

Since 1947

16030 Park Avenue, Harvey, IL 60426

Ph: 708.333.1900 F: 708.333.1910

www.harveycement.com

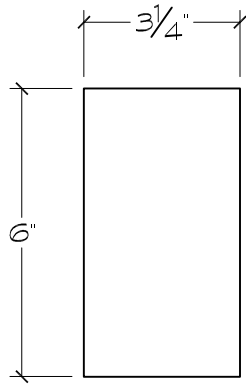

Standard Length 23 5/8"

CROSS SECTION

1 **PROFILE GZ**
 ARCH REF:
 SCALE: 3"=1'-0"

Profile ID

GZ

SUGGESTED USE

Sill	
Transition Band	
Coping	
Cap	
Band	X
Cornice	

**TYPE / SIZE
 AVAILABILITY**

TYPE	LENGTH(S)
Straight	Up to 25 13/16"
Left End Return	
Right End Return	

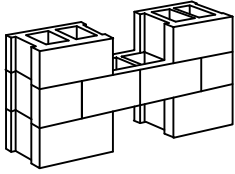

Harvey Cement Products, Inc.

Since 1947

16030 Park Avenue, Harvey, IL 60426

Ph: 708.333.1900 F: 708.333.1910

www.harveycement.com

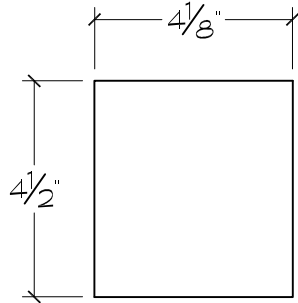

CROSS SECTION

① **PROFILE HG**
 ARCH REF:
 SCALE: 3"=1'-0"

Profile ID

HG

SUGGESTED USE

Sill	
Transition Band	
Coping	
Cap	
Band	X
Cornice	

**TYPE / SIZE
 AVAILABILITY**

TYPE	LENGTH(S)
Straight	23 5/8"

DRIP EDGE - OPTIONAL

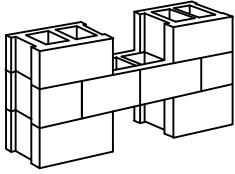

Harvey Cement Products, Inc.

Since 1947

16030 Park Avenue, Harvey, IL 60426

Ph: 708.333.1900 F: 708.333.1910

www.harveycement.com

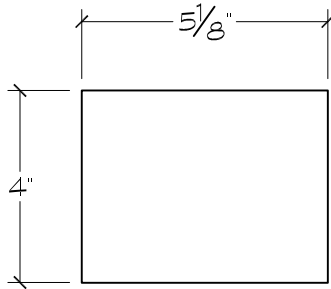

CROSS SECTION

1 **PROFILE HJ**
 ARCH REF:
 SCALE: 3"=1'-0"

Profile ID

HJ

SUGGESTED USE

Sill	
Transition Band	
Coping	
Cap	
Band	X
Cornice	

**TYPE / SIZE
 AVAILABILITY**

TYPE	LENGTH(S)
Straight	Up to 27 1/4"
Left End Return	Up to 34 7/8"
Right End Return	Up to 34 7/8"

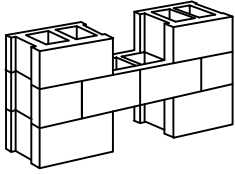

Harvey Cement Products, Inc.

Since 1947

16030 Park Avenue, Harvey, IL 60426

Ph: 708.333.1900 F: 708.333.1910

www.harveycement.com

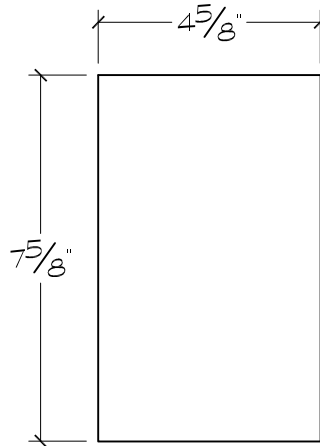

CROSS SECTION

① **PROFILE JB**

ARCH REF:
SCALE: 3"=1'-0"

FRONT VIEW

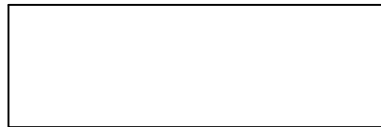

STRAIGHT

Profile ID

JB

SUGGESTED USE

Sill	
Transition Band	
Coping	
Cap	
Band	X
Field	

**TYPE / SIZE
AVAILABILITY**

TYPE	LENGTH(S)
Straight	23 5/8"

DRIP EDGE - OPTIONAL

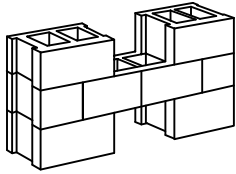

Harvey Cement Products, Inc.

Since 1947

16030 Park Avenue, Harvey, IL 60426

Ph: 708.333.1900 F: 708.333.1910

www.harveycement.com

PROFILE TYPE:

RECTANGULAR

SURFACE FINISH:

TEXTURED

ROCKFACE / SLATE

REFER TO
INDIVIDUAL
PROFILE (ID) PAGES
FOR DETAILS
AND LENGTHS
AVAILABLE.

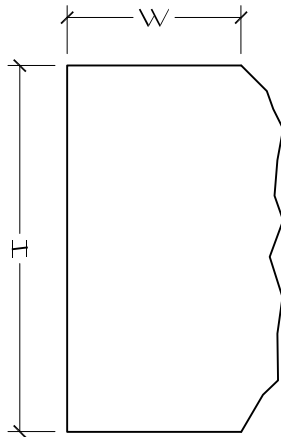

	W	H	TEXTURE	ID
	3 ⁵ / ₈ "	3 ⁵ / ₈ "	Rockface	BG
	3 ⁵ / ₈ "	7 ⁵ / ₈ "	Rockface	B
	3 ⁵ / ₈ "	11 ⁵ / ₈ "	Rockface	R
	3 ⁵ / ₈ "	3 ⁵ / ₈ "	Slate	HQ
	3 ⁵ / ₈ "	7 ⁵ / ₈ "	Slate	HP

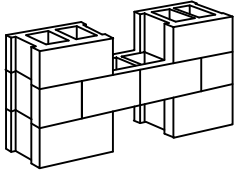

Harvey Cement Products, Inc.

Since 1947

16030 Park Avenue, Harvey, IL 60426

Ph: 708.333.1900 F: 708.333.1910

www.harveycement.com

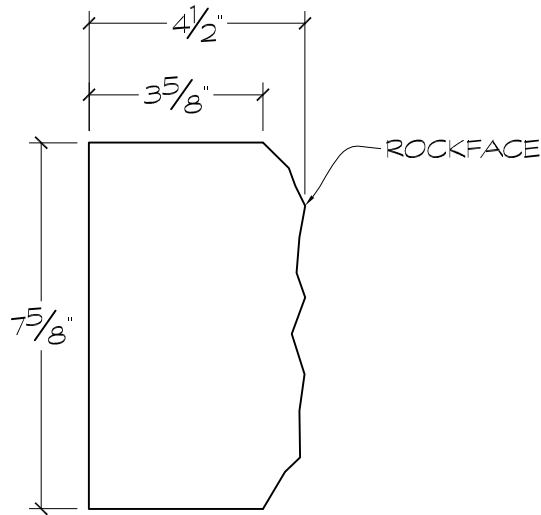

CROSS SECTION

1 **PROFILE B**
ARCH REF:
SCALE: 3"=1'-0"

Profile ID

B

SUGGESTED USE

Sill	
Transition Band	
Coping	
Cap	
Field / Band	X
Cornice	

TYPE / SIZE
AVAILABILITY

TYPE	LENGTH(S)
Straight	23 5/8"
Finished End	15 5/8"
Inside Return	15 5/8"
Outside Return	23 5/8"

TOP VIEWS

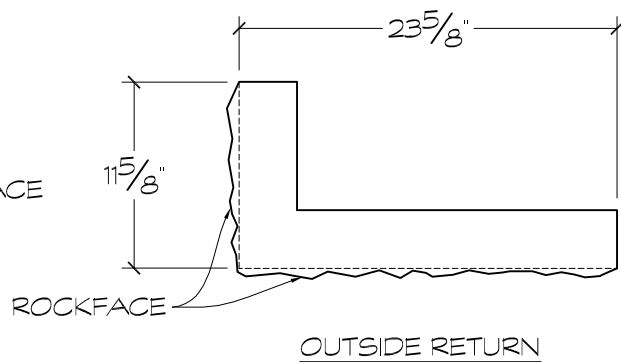
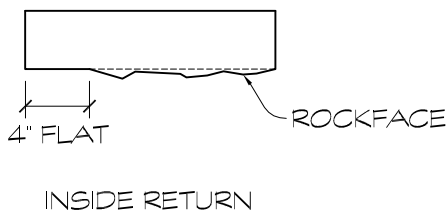
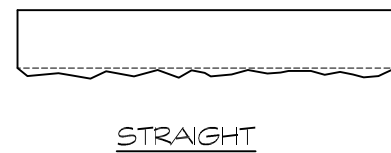
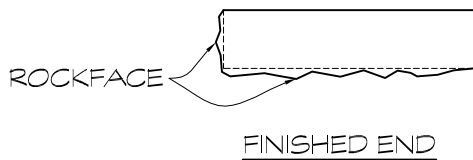

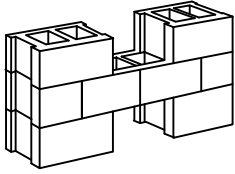

Harvey Cement Products, Inc.

Since 1947

16030 Park Avenue, Harvey, IL 60426

Ph: 708.333.1900 F: 708.333.1910

www.harveycement.com

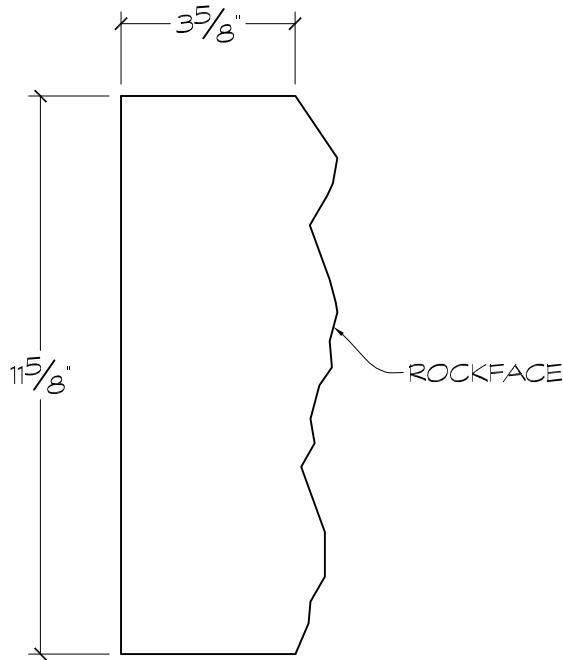

CROSS SECTION

1 **PROFILE R**
 ARCH REF:
 SCALE: 3"=1'-0"

Profile ID

R

SUGGESTED USE

Sill	
Transition Band	
Coping	
Cap	
Field / Band	X
Cornice	

**TYPE / SIZE
 AVAILABILITY**

TYPE	LENGTH(S)
Straight	23 5/8"

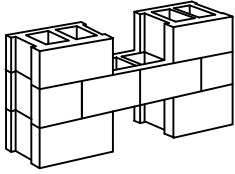

Harvey Cement Products, Inc.

Since 1947

16030 Park Avenue, Harvey, IL 60426

Ph: 708.333.1900 F: 708.333.1910

www.harveycement.com

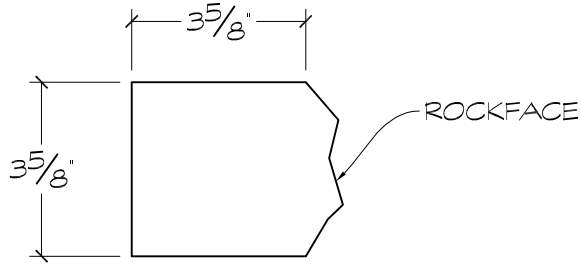

CROSS SECTION

1

PROFILE BG

ARCH REF:
SCALE: 3"=1'-0"

Profile ID

BG

SUGGESTED USE

Sill	
Transition Band	
Coping	
Cap	
Field / Band	X
Cornice	

**TYPE / SIZE
AVAILABILITY**

TYPE	LENGTH(S)
Straight	23 5/8"

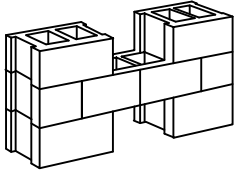

Harvey Cement Products, Inc.

Since 1947

16030 Park Avenue, Harvey, IL 60426

Ph: 708.333.1900 F: 708.333.1910

www.harveycement.com

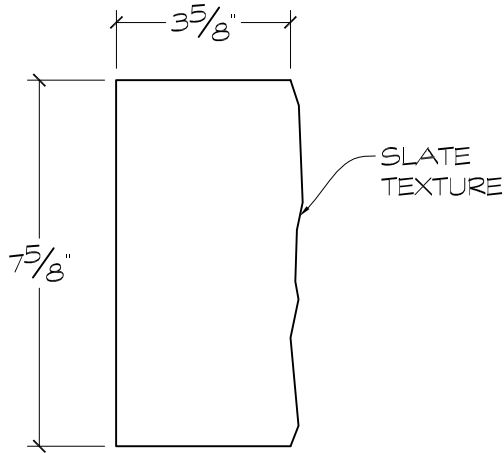

CROSS SECTION

1 **PROFILE HP**
 ARCH REF:
 SCALE: 3"=1'-0"

Profile ID

HP

SUGGESTED USE

Sill	
Transition Band	
Coping	
Cap	
Band	X
Field	X

TYPE / SIZE AVAILABILITY

TYPE	LENGTH(S)
Straight	23 5/8"
Finished End	15 5/8"

TOP VIEWS



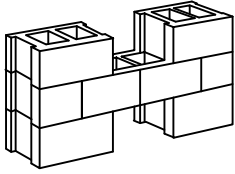

Harvey Cement Products, Inc.

Since 1947

16030 Park Avenue, Harvey, IL 60426

Ph: 708.333.1900 F: 708.333.1910

www.harveycement.com

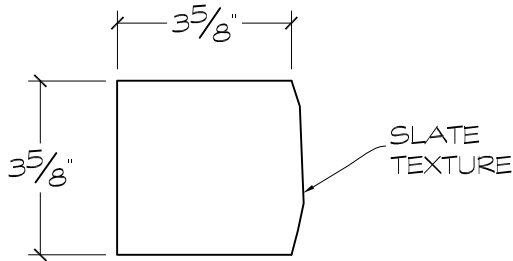

CROSS SECTION

1 **PROFILE HQ**
 ARCH REF:
 SCALE: 3"=1'-0"

Profile ID

HQ

SUGGESTED USE

Sill	
Transition Band	
Coping	
Cap	
Band	X
Field	X

TYPE / SIZE AVAILABILITY

TYPE	LENGTH(S)
Straight	23 5/8"
Finished End	15 5/8"

TOP VIEWS



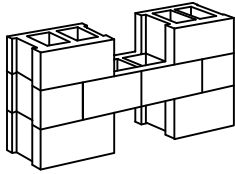

Harvey Cement Products, Inc.

Since 1947

16030 Park Avenue, Harvey, IL 60426

Ph: 708.333.1900 F: 708.333.1910

www.harveycement.com

PROFILE TYPE:

CHAMFERED

SURFACE FINISH:

SMOOTH

REFER TO
INDIVIDUAL
PROFILE (ID) PAGES
FOR DETAILS
AND LENGTHS
AVAILABLE.

	W	H	T	F	ID
	3 1/2"	3 5/8"	2 1/4"	2 5/8"	GT
	3 5/8"	3 5/8"	2 5/8"	3"	HR
	3 5/8"	3 5/8"	3 1/8"	3"	HZ
	4 5/8"	7 5/8"	3 5/8"	6 5/8"	GF
	4 5/8"	7 5/8"	3 5/8"	7 1/8"	BZ
	4 5/8"	15 5/8"	3 5/8"	14 5/8"	ES
	5"	2 1/4"	3 1/2"	1 3/4"	HD
	5"	6 3/4"	2 1/4"	5 3/4"	GR
	5 1/8"	1 5/8"	3 5/8"	1 1/8"	L
	5 1/8"	2 1/4"	1"	1 3/4"	AA
	5 1/8"	2 3/8"	3 5/8"	1 7/8"	CF
	5 1/8"	3 5/8"	5/8"	3 1/8"	M
	5 1/8"	3 5/8"	1 5/8"	3 1/8"	S
	5 1/8"	3 5/8"	3 5/8"	3 1/8"	A
	5 1/8"	7 5/8"	1 1/4"	6 5/8"	JC
	5 1/8"	8"	3 5/8"	7 3/8"	GG
	5 3/8"	7"	1 7/8"	5"	CN
	5 1/2"	6 1/2"	4 1/2"	5 1/2"	CR
	5 5/8"	3 1/4"	3 5/8"	2 1/4"	AX
	5 5/8"	3 5/8"	3 5/8"	3 1/8"	AH
	5 5/8"	3 5/8"	4 1/8"	3 1/2"	JA
	5 5/8"	15 5/8"	3 5/8"	13 5/8"	GJ
	6 1/8"	3 5/8"	4 5/8"	3 1/8"	CP
	6 1/4"	2 1/4"	4 5/8"	1 1/2"	BX
	6 5/8"	3 5/8"	5 1/8"	3 1/8"	GB
	6 5/8"	7 3/8"	3 5/8"	6 3/8"	EM

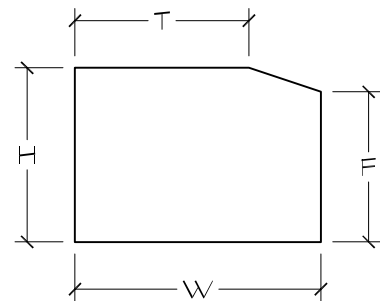

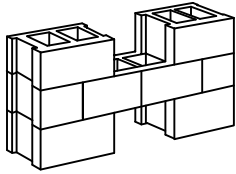

Harvey Cement Products, Inc.

Since 1947

16030 Park Avenue, Harvey, IL 60426

Ph: 708.333.1900 F: 708.333.1910

www.harveycement.com

PROFILE TYPE:

CHAMFERED

PAGE 2

SURFACE FINISH:

SMOOTH

REFER TO
INDIVIDUAL
PROFILE (ID) PAGES
FOR DETAILS
AND LENGTHS
AVAILABLE.

	W	H	T	F	ID
	7"	7 ³ / ₈ "	3 ³ / ₄ "	6 ³ / ₈ "	EY
	7 ¹ / ₈ "	4"	5 ⁵ / ₈ "	3 ³ / ₈ "	CJ
	7 ⁵ / ₈ "	3 ⁵ / ₈ "	1"	3 ¹ / ₈ "	BP
	7 ⁵ / ₈ "	3 ⁵ / ₈ "	3 ⁵ / ₈ "	2 ⁵ / ₈ "	AV
	7 ⁵ / ₈ "	3 ⁵ / ₈ "	3 ⁵ / ₈ "	3 ³ / ₈ "	Y
	7 ⁵ / ₈ "	3 ⁵ / ₈ "	5 ⁵ / ₈ "	3 ³ / ₈ "	AT
	7 ⁵ / ₈ "	3 ⁵ / ₈ "	6 ¹ / ₈ "	3 ³ / ₈ "	G
	7 ⁵ / ₈ "	6"	5 ¹ / ₈ "	2"	HW
	7 ⁵ / ₈ "	6 ¹ / ₄ "	3 ⁵ / ₈ "	5 ¹ / ₄ "	AW
	8 ³ / ₈ "	2 ¹ / ₈ "	7 ³ / ₈ "	1 ¹ / ₈ "	AF
	9 ¹ / ₈ "	3 ⁵ / ₈ "	3 ⁵ / ₈ "	3 ³ / ₈ "	HK
	9 ⁵ / ₈ "	6 ¹ / ₈ "	7 ¹ / ₈ "	3"	HS
	9 ⁵ / ₈ "	7 ³ / ₈ "	7 ¹ / ₈ "	3"	HH
	9 ⁵ / ₈ "	8 ¹ / ₈ "	7 ⁵ / ₈ "	3"	HT

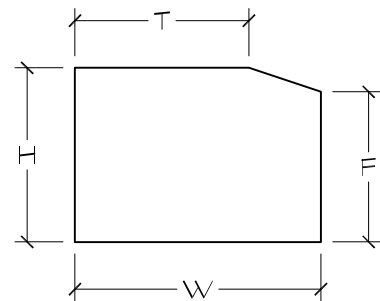

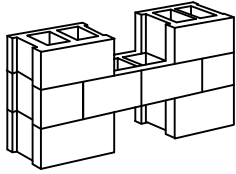

Harvey Cement Products, Inc.

Since 1947

16030 Park Avenue, Harvey, IL 60426

Ph: 708.333.1900 F: 708.333.1910

www.harveycement.com

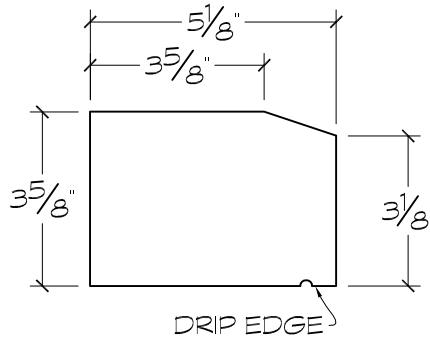

CROSS SECTION

① **PROFILE A**
 ARCH REF:
 SCALE: 3"=1'-0"

CAN BE USED AS CORNICE WITH CHAMFER AT BOTTOM EDGE

TOP VIEWS

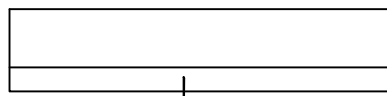

STRAIGHT - Standard Length 23 5/8"

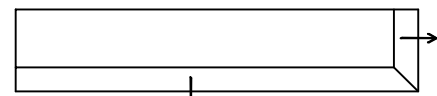

RIGHT END RETURN

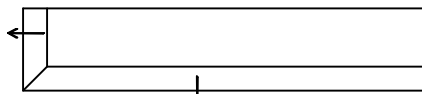

LEFT END RETURN

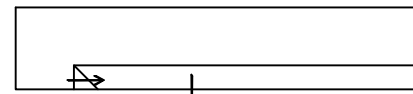

LEFT INSIDE RETURN

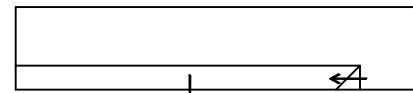

RIGHT INSIDE RETURN

DRIP EDGE - OPTIONAL

Profile ID

A

SUGGESTED USE

Sill	X
Transition Band	X
Coping	
Cap	
Band	X
Cornice	X

TYPE / SIZE AVAILABILITY

TYPE	LENGTH(S)
Straight	Up to 51 1/2"
Left End Return	25 1/8"
Right End Return	25 1/8"
Left Inside Return	25 1/8"
Right Inside Return	25 1/8"

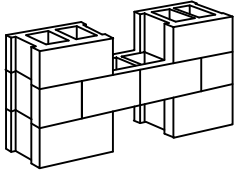

Harvey Cement Products, Inc.

Since 1947

16030 Park Avenue, Harvey, IL 60426

Ph: 708.333.1900 F: 708.333.1910

www.harveycement.com

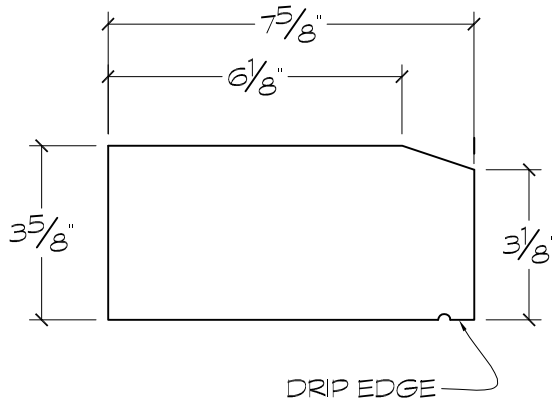

CROSS SECTION

1 **PROFILE G**
 ARCH REF:
 SCALE: 3"=1'-0"

Profile ID

G

SUGGESTED USE

Sill	X
Transition Band	X
Coping	
Cap	X
Field / Band	
Cornice	

TYPE / SIZE AVAILABILITY

TYPE	LENGTH(S)
Straight	Up to 35 5/8"
Left End Return	Up to 37 5/8"
Right End Return	Up to 37 5/8"

TOP VIEWS

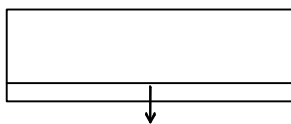

STRAIGHT

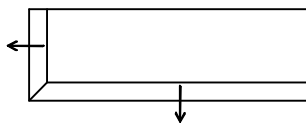

LEFT END RETURN

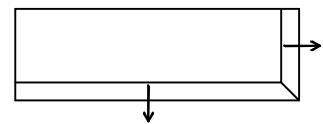

RIGHT END RETURN

DRIP EDGE - OPTIONAL

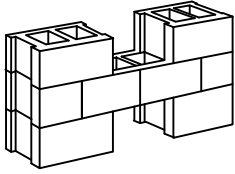

Harvey Cement Products, Inc.

Since 1947

16030 Park Avenue, Harvey, IL 60426

Ph: 708.333.1900 F: 708.333.1910

www.harveycement.com

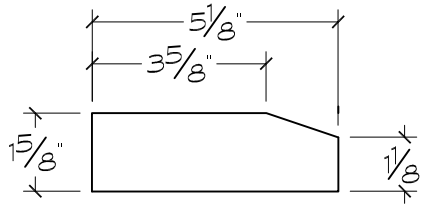

CROSS SECTION

① **PROFILE L**
 ARCH REF:
 SCALE: 3"=1'-0"

CAN BE USED AS CORNICE WITH CHAMFER AT BOTTOM EDGE

Profile ID

L

SUGGESTED USE

Sill	×
Transition Band	×
Coping	
Cap	×
Band	×
Cornice	×

TYPE / SIZE AVAILABILITY

TYPE	LENGTH(S)
Straight	23 5/8"
Left End Return	25 1/8"
Right End Return	25 1/8"

TOP VIEWS

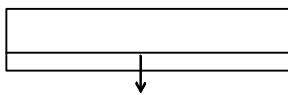

STRAIGHT

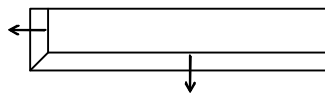

LEFT END RETURN

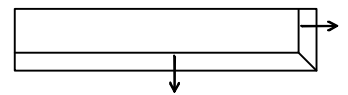

RIGHT END RETURN

DRIP EDGE - OPTIONAL

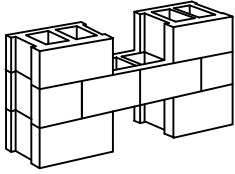

Harvey Cement Products, Inc.

Since 1947

16030 Park Avenue, Harvey, IL 60426

Ph: 708.333.1900 F: 708.333.1910

www.harveycement.com

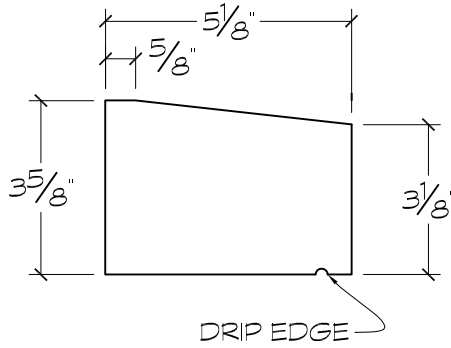

CROSS SECTION

① **PROFILE M**
 ARCH REF:
 SCALE: 3"=1'-0"

Profile ID

M

SUGGESTED USE

Sill	X
Transition Band	
Coping	
Cap	
Field / Band	
Cornice	

TYPE / SIZE AVAILABILITY

TYPE	LENGTH(S)
Straight	Up to 51 1/2"

DRIP EDGE - OPTIONAL

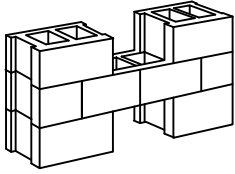

Harvey Cement Products, Inc.

Since 1947

16030 Park Avenue, Harvey, IL 60426

Ph: 708.333.1900 F: 708.333.1910

www.harveycement.com

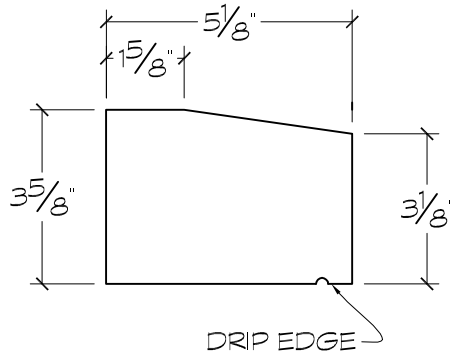

CROSS SECTION

1 **PROFILE S**
 ARCH REF:
 SCALE: 3"=1'-0"

Profile ID

S

SUGGESTED USE

Sill	X
Transition Band	X
Coping	
Cap	
Field / Band	
Cornice	

TYPE / SIZE
 AVAILABILITY

TYPE	LENGTH(S)
Straight	up to 53"
Left End Return	25 1/8"
Right End Return	25 1/8"

TOP VIEWS



STRAIGHT-Standard Length 23 5/8"

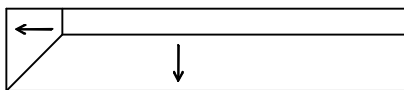

LEFT END RETURN

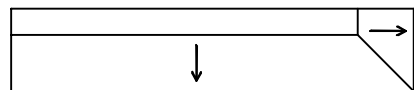

RIGHT END RETURN

DRIP EDGE - OPTIONAL

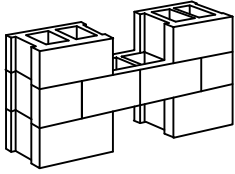

Harvey Cement Products, Inc.

Since 1947

16030 Park Avenue, Harvey, IL 60426

Ph: 708.333.1900 F: 708.333.1910

www.harveycement.com

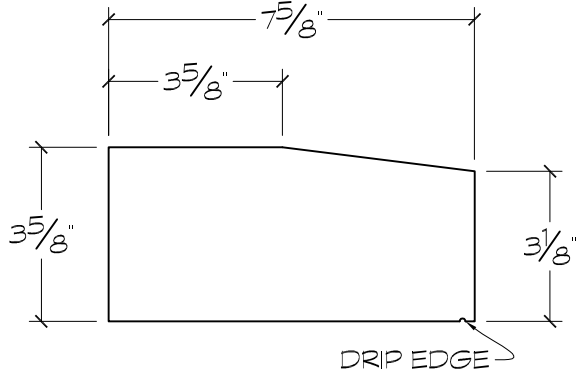

CROSS SECTION

1 **PROFILE Y**
 ARCH REF:
 SCALE: 3"=1'-0"

CAN BE USED AS CORNICE WITH CHAMFER AT BOTTOM EDGE

Profile ID

Y

SUGGESTED USE

Sill	X
Transition Band	X
Coping	
Cap	X
Band	X
Cornice	X

TYPE / SIZE AVAILABILITY

TYPE	LENGTH(S)
Straight	35 5/8"
Left End Return	35 5/8"
Right End Return	35 5/8"

TOP VIEWS

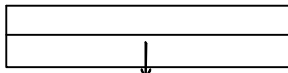

STRAIGHT

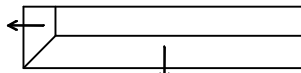

LEFT END RETURN

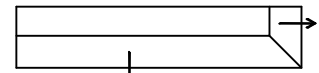

RIGHT END RETURN

DRIP EDGE - OPTIONAL

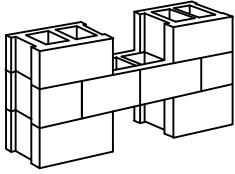

Harvey Cement Products, Inc.

Since 1947

16030 Park Avenue, Harvey, IL 60426

Ph: 708.333.1900 F: 708.333.1910

www.harveycement.com

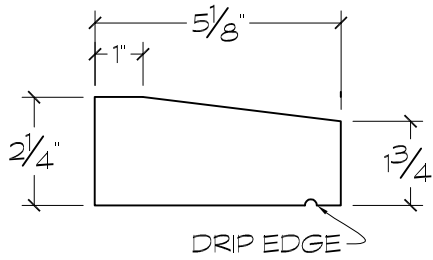

CROSS SECTION

1 **PROFILE AA**
 ARCH REF:
 SCALE: 3"=1'-0"

Profile ID

AA

SUGGESTED USE

Sill	X
Transition Band	X
Coping	
Cap	
Field / Band	
Cornice	

TYPE / SIZE
 AVAILABILITY

TYPE	LENGTH(S)
Straight	23 5/8"

DRIP EDGE - OPTIONAL

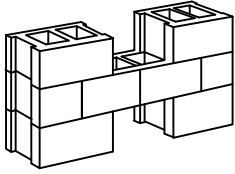

Harvey Cement Products, Inc.

Since 1947

16030 Park Avenue, Harvey, IL 60426

Ph: 708.333.1900 F: 708.333.1910

www.harveycement.com

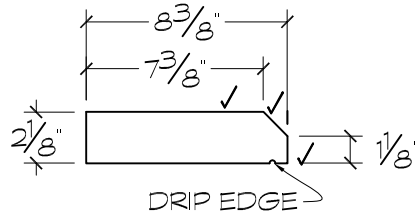

CROSS SECTION

① **PROFILE AF**

ARCH REF:
SCALE: 1-1/2"=1'-0"

CAN BE USED AS CORNICE WITH CHAMFER AT BOTTOM EDGE

Profile ID

AF

SUGGESTED USE

Sill	×
Transition Band	×
Coping	
Cap	×
Band	×
Cornice	×

TYPE / SIZE AVAILABILITY

TYPE	LENGTH(S)
Straight	23 5/8"
Left End Return	25 1/8"
Right End Return	25 1/8"

TOP VIEWS

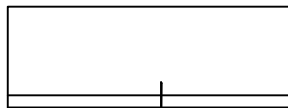

STRAIGHT

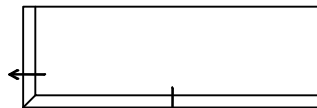

LEFT END RETURN

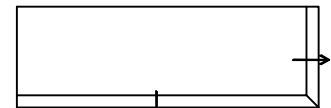

RIGHT END RETURN

DRIP EDGE - OPTIONAL

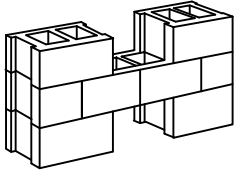

Harvey Cement Products, Inc.

Since 1947

16030 Park Avenue, Harvey, IL 60426

Ph: 708.333.1900 F: 708.333.1910

www.harveycement.com

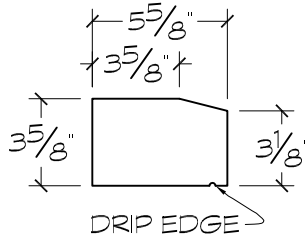

CROSS SECTION

① **PROFILE AH**
 ARCH REF:
 SCALE: 1-1/2"=1'-0"

CAN BE USED AS CORNICE WITH CHAMFER AT BOTTOM EDGE

Profile ID

AH

SUGGESTED USE

Sill	×
Transition Band	×
Coping	
Cap	×
Band	×
Cornice	×

**TYPE / SIZE
 AVAILABILITY**

TYPE	LENGTH(S)
Straight	Up to 35 5/8"
Left End Return	Up to 35 5/8"
Right End Return	Up to 35 5/8"

TOP VIEWS

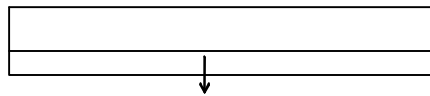

STRAIGHT

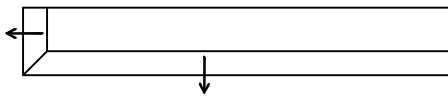

LEFT END RETURN



RIGHT END RETURN

DRIP EDGE - OPTIONAL

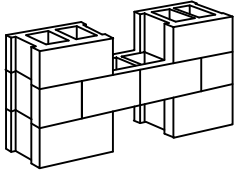

Harvey Cement Products, Inc.

Since 1947

16030 Park Avenue, Harvey, IL 60426

Ph: 708.333.1900 F: 708.333.1910

www.harveycement.com

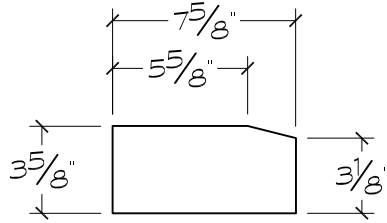

CROSS SECTION

① **PROFILE AT**
 ARCH REF:
 SCALE: 1-1/2"=1'-0"

CAN BE USED AS CORNICE WITH CHAMFER AT BOTTOM EDGE

DRIP EDGE - OPTIONAL

Profile ID

AT

SUGGESTED USE

Sill	×
Transition Band	×
Coping	
Cap	×
Band	×
Cornice	×

**TYPE / SIZE
 AVAILABILITY**

TYPE	LENGTH(S)
Straight	Up to 35 5/8"

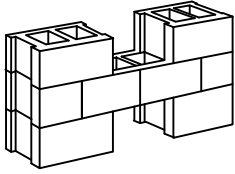

Harvey Cement Products, Inc.

Since 1947

16030 Park Avenue, Harvey, IL 60426

Ph: 708.333.1900 F: 708.333.1910

www.harveycement.com

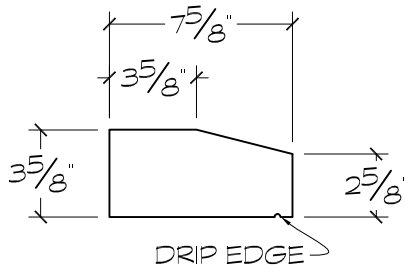

CROSS SECTION

1 **PROFILE AV**
 ARCH REF:
 SCALE: 1-1/2"=1'-0"

Profile ID

AV

SUGGESTED USE

Sill	X
Transition Band	
Coping	
Cap	
Band	
Cornice	

TYPE / SIZE
 AVAILABILITY

TYPE	LENGTH(S)
Straight	Up to 35 5/8"

DRIP EDGE - OPTIONAL

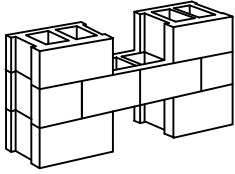

Harvey Cement Products, Inc.

Since 1947

16030 Park Avenue, Harvey, IL 60426

Ph: 708.333.1900 F: 708.333.1910

www.harveycement.com

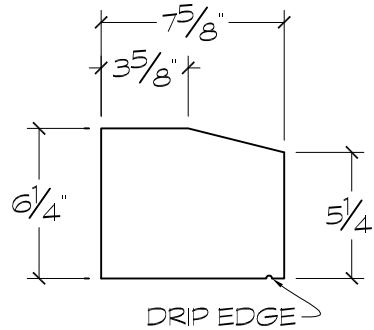

CROSS SECTION

1 **PROFILE AW**

ARCH REF:
SCALE: 1-1/2"=1'-0"

Profile ID

AW

SUGGESTED USE

Sill	
Transition Band	X
Coping	
Cap	X
Band	X
Cornice	

TYPE / SIZE AVAILABILITY

TYPE	LENGTH(S)
Straight	23 5/8"
Left End Return	25 5/8"
Right End Return	25 5/8"

TOP VIEWS

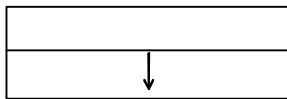

STRAIGHT

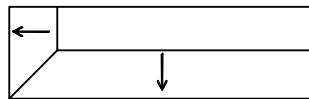

LEFT END RETURN

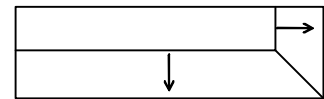

RIGHT END RETURN

DRIP EDGE - OPTIONAL

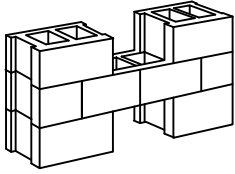

Harvey Cement Products, Inc.

Since 1947

16030 Park Avenue, Harvey, IL 60426

Ph: 708.333.1900 F: 708.333.1910

www.harveycement.com

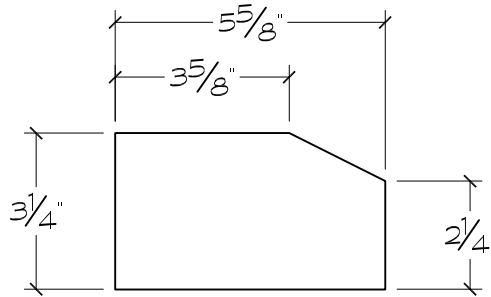

CROSS SECTION

1 **PROFILE AX**

ARCH REF:
SCALE: 3"=1'-0"

CAN BE USED AS CORNICE WITH CHAMFER AT BOTTOM EDGE

Profile ID

AX

SUGGESTED USE

Sill	
Transition Band	X
Coping	
Cap	X
Band	X
Cornice	X

TYPE / SIZE
AVAILABILITY

TYPE	LENGTH(S)
Straight	23 5/8"
Left End Return	25 5/8"
Right End Return	25 5/8"

TOP VIEWS

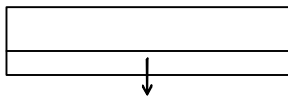

STRAIGHT

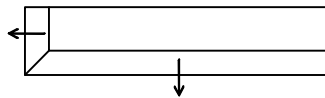

LEFT END RETURN



RIGHT END RETURN

DRIP EDGE - OPTIONAL

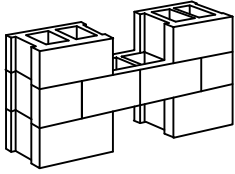

Harvey Cement Products, Inc.

Since 1947

16030 Park Avenue, Harvey, IL 60426

Ph: 708.333.1900 F: 708.333.1910

www.harveycement.com

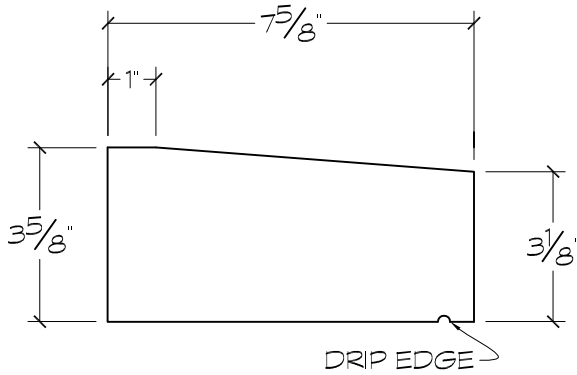

CROSS SECTION

1

PROFILE BP

ARCH REF:
SCALE: 3"=1'-0"

Profile ID

BP

SUGGESTED USE

Sill	X
Transition Band	X
Coping	
Cap	
Field / Band	
Cornice	

TYPE / SIZE AVAILABILITY

TYPE	LENGTH(S)
Straight	Up to 35 5/8"

DRIP EDGE - OPTIONAL

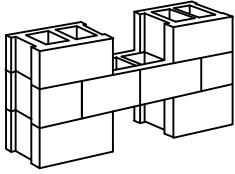

Harvey Cement Products, Inc.

Since 1947

16030 Park Avenue, Harvey, IL 60426

Ph: 708.333.1900 F: 708.333.1910

www.harveycement.com

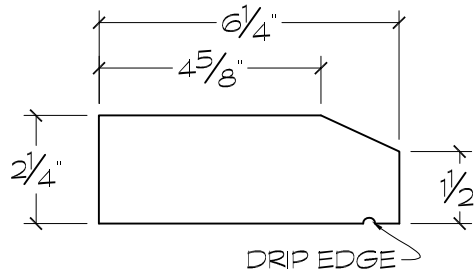

CROSS SECTION

① **PROFILE BX**

ARCH REF:
SCALE: 3"=1'-0"

CAN BE USED AS CORNICE WITH CHAMFER AT BOTTOM EDGE

Profile ID

BX

SUGGESTED USE

Sill	×
Transition Band	×
Coping	
Cap	×
Band	×
Cornice	×

TYPE / SIZE AVAILABILITY

TYPE	LENGTH(S)
Straight	23 5/8"
Left End Return	24 5/8"
Right End Return	24 5/8"

TOP VIEWS

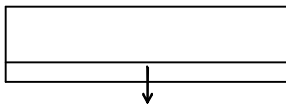

STRAIGHT

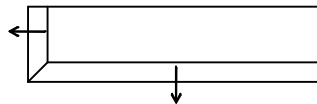

LEFT END RETURN

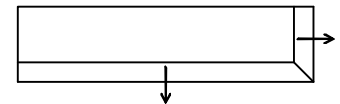

RIGHT END RETURN

DRIP EDGE - OPTIONAL

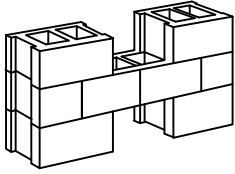

Harvey Cement Products, Inc.

Since 1947

16030 Park Avenue, Harvey, IL 60426

Ph: 708.333.1900 F: 708.333.1910

www.harveycement.com

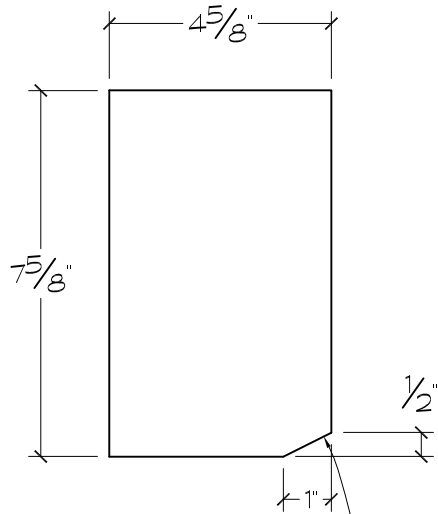

CROSS SECTION

1

PROFILE BZ

ARCH REF:
SCALE: 3"=1'-0"

CHAMFER LOWER
CORNER FOR
CORNICE USE

CHAMFER UPPER
CORNER FOR USE
AS BAND

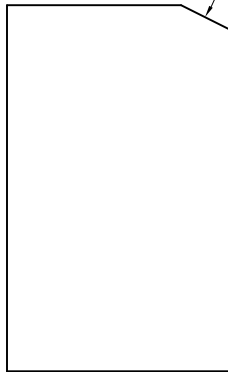

CAN BE USED AS CORNICE WITH CHAMFER AT BOTTOM EDGE

FRONT VIEWS



STRAIGHT

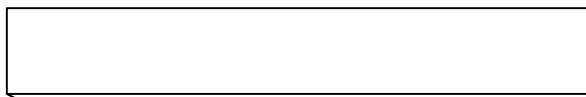

LEFT END RETURN

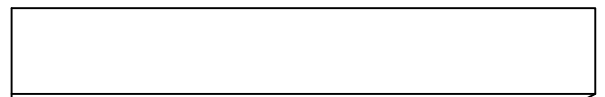

RIGHT END RETURN

DRIP EDGE - OPTIONAL

Profile ID

BZ

SUGGESTED USE

Sill	X
Transition Band	X
Coping	
Cap	X
Band	X
Cornice	X

**TYPE / SIZE
AVAILABILITY**

TYPE	LENGTH(S)
Straight	Up to 47 5/8"
Left End Return	Up to 48 5/8"
Right End Return	Up to 48 5/8"

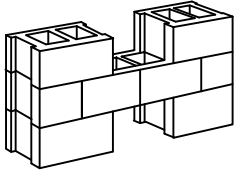

Harvey Cement Products, Inc.

Since 1947

16030 Park Avenue, Harvey, IL 60426

Ph: 708.333.1900 F: 708.333.1910

www.harveycement.com

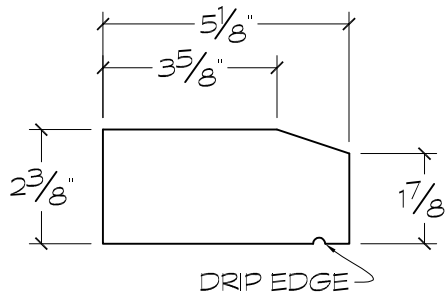

CROSS SECTION

① **PROFILE CF**
 ARCH REF:
 SCALE: 3"=1'-0"

Profile ID

CF

SUGGESTED USE

Sill	X
Transition Band	
Coping	
Cap	
Field / Band	
Cornice	

TYPE / SIZE
 AVAILABILITY

TYPE	LENGTH(S)
Straight	Up to 24 7/8"

DRIP EDGE - OPTIONAL

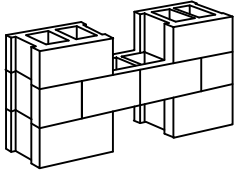

Harvey Cement Products, Inc.

Since 1947

16030 Park Avenue, Harvey, IL 60426

Ph: 708.333.1900 F: 708.333.1910

www.harveycement.com

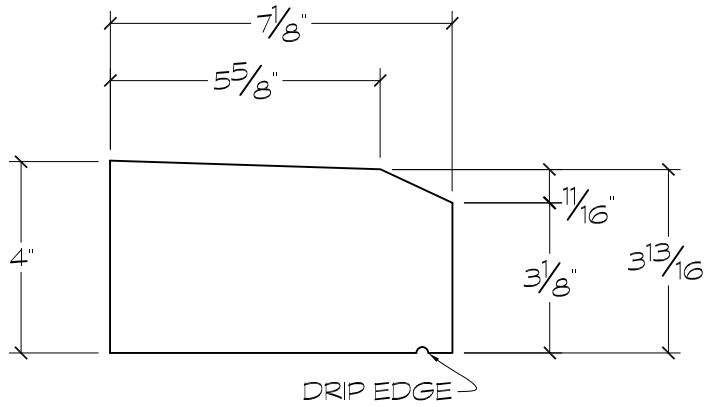

CROSS SECTION

1

PROFILE CJ

ARCH REF:

SCALE: 3"=1'-0"

Profile ID

CJ

SUGGESTED USE

Sill	X
Transition Band	
Coping	
Cap	
Field / Band	
Cornice	

TYPE / SIZE
AVAILABILITY

TYPE	LENGTH(S)
Straight	Up to $47\frac{5}{8}$ "

DRIP EDGE - OPTIONAL

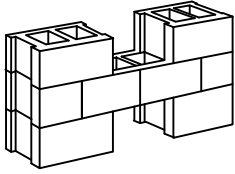

Harvey Cement Products, Inc.

Since 1947

16030 Park Avenue, Harvey, IL 60426

Ph: 708.333.1900 F: 708.333.1910

www.harveycement.com

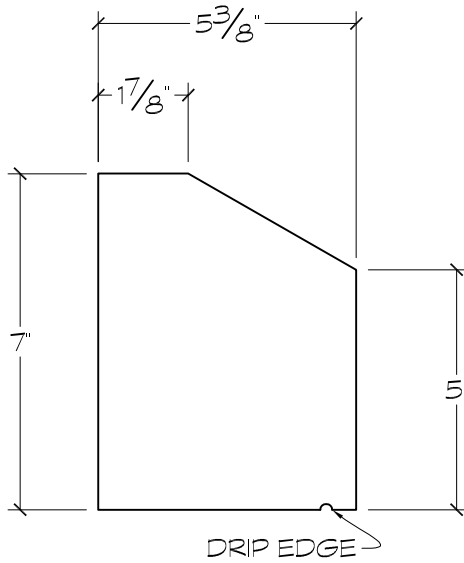

CROSS SECTION

1 **PROFILE CN**
 ARCH REF:
 SCALE: 3"=1'-0"

Profile ID

CN

SUGGESTED USE

Sill	X
Transition Band	X
Coping	
Cap	X
Field / Band	
Cornice	

TYPE / SIZE AVAILABILITY

TYPE	LENGTH(S)
Straight	35 5/8"
Left End Return	35 5/8"
Right End Return	35 5/8"

TOP VIEWS



STRAIGHT

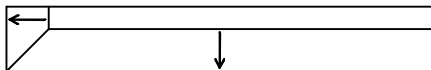

LEFT END RETURN

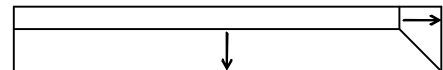

RIGHT END RETURN

DRIP EDGE - OPTIONAL

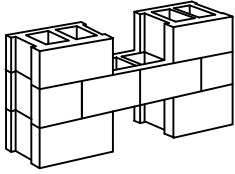

Harvey Cement Products, Inc.

Since 1947

16030 Park Avenue, Harvey, IL 60426

Ph: 708.333.1900 F: 708.333.1910

www.harveycement.com

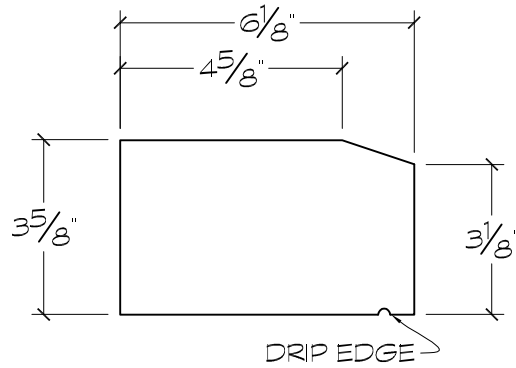

CROSS SECTION

1 **PROFILE CP**
 ARCH REF:
 SCALE: 3"=1'-0"

Profile ID

CP

SUGGESTED USE

Sill	X
Transition Band	
Coping	
Cap	
Field / Band	
Cornice	

TYPE / SIZE AVAILABILITY

TYPE	LENGTH(S)
Straight	23 5/8"
Left End Return	25 1/8"

TOP VIEWS

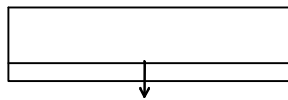

STRAIGHT

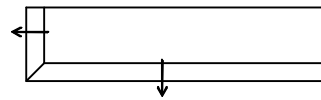

LEFT END RETURN

DRIP EDGE - OPTIONAL

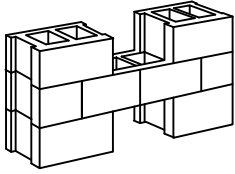

Harvey Cement Products, Inc.

Since 1947

16030 Park Avenue, Harvey, IL 60426

Ph: 708.333.1900 F: 708.333.1910

www.harveycement.com

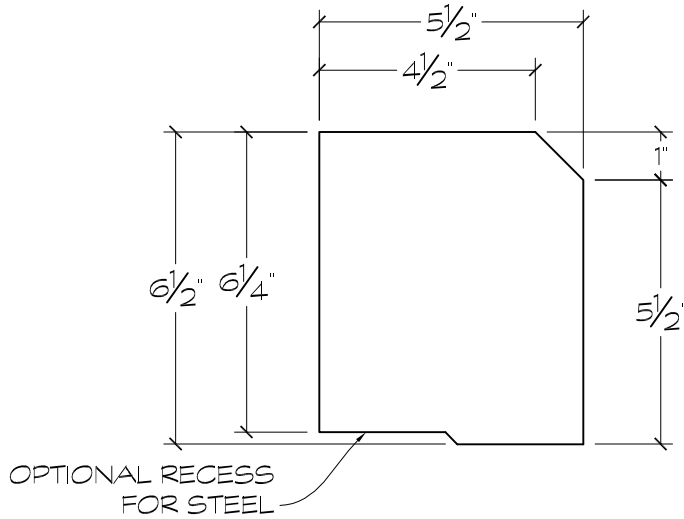

CROSS SECTION

1 PROFILE CR
 ARCH REF:
 SCALE: 3"=1'-0"

Profile ID

CR

SUGGESTED USE

Sill	
Transition Band	
Coping	
Cap	
Band	
Cornice	
Header	X

TYPE / SIZE
 AVAILABILITY

TYPE	LENGTH(S)
Straight	Up to 39"

DRIP EDGE - OPTIONAL

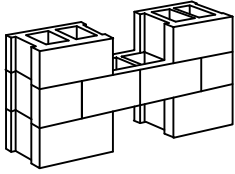

Harvey Cement Products, Inc.

Since 1947

16030 Park Avenue, Harvey, IL 60426

Ph: 708.333.1900 F: 708.333.1910

www.harveycement.com

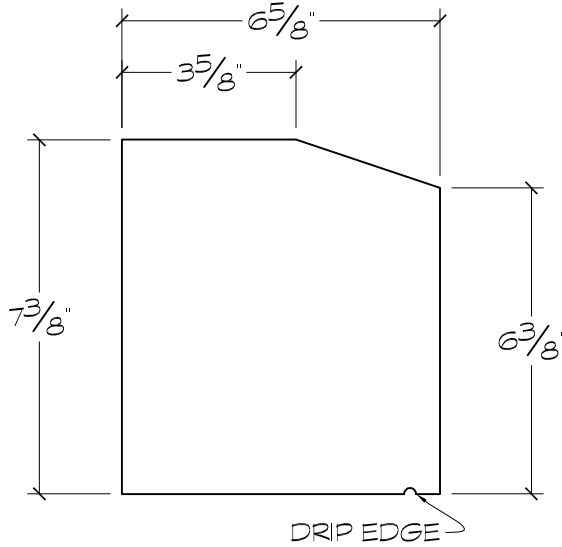

CROSS SECTION

1 **PROFILE EM**
 ARCH REF:
 SCALE: 3"=1'-0"

CAN BE USED AS CORNICE WITH CHAMFER AT BOTTOM EDGE

Profile ID

EM

SUGGESTED USE

Sill	×
Transition Band	×
Coping	
Cap	×
Band	×
Cornice	×

TYPE / SIZE AVAILABILITY

TYPE	LENGTH(S)
Straight	23 5/8"
Left End Return	Up to 29 1/6"
Right End Return	Up to 29 1/6"

TOP VIEWS

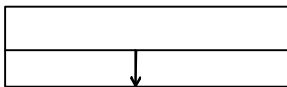

STRAIGHT



LEFT END RETURN



RIGHT END RETURN

DRIP EDGE - OPTIONAL

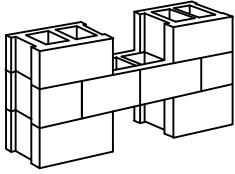

Harvey Cement Products, Inc.

Since 1947

16030 Park Avenue, Harvey, IL 60426

Ph: 708.333.1900 F: 708.333.1910

www.harveycement.com

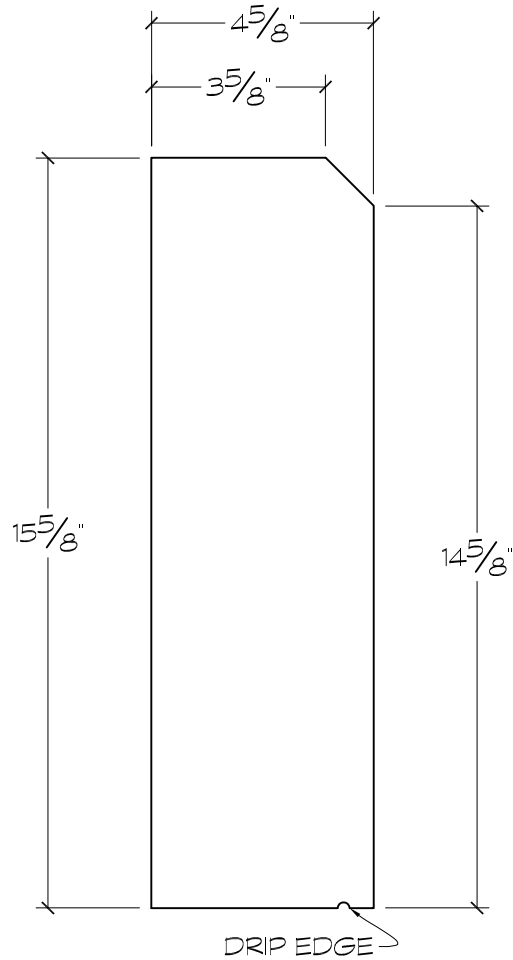

CROSS SECTION

1 **PROFILE ES**

ARCH REF:
SCALE: 3"=1'-0"

TOP VIEWS

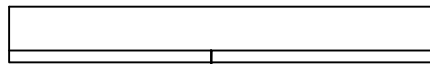

STRAIGHT

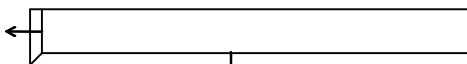

LEFT END RETURN

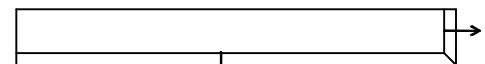

RIGHT END RETURN

DRIP EDGE - OPTIONAL

Profile ID

ES

SUGGESTED USE

Sill	
Transition Band	X
Coping	
Cap	
Band	X
Cornice	

TYPE / SIZE AVAILABILITY

TYPE	LENGTH(S)
Straight	35 5/8"
Left End Return	36 5/8"
Right End Return	36 5/8"

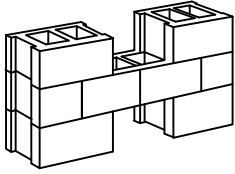

Harvey Cement Products, Inc.

Since 1947

16030 Park Avenue, Harvey, IL 60426

Ph: 708.333.1900 F: 708.333.1910

www.harveycement.com

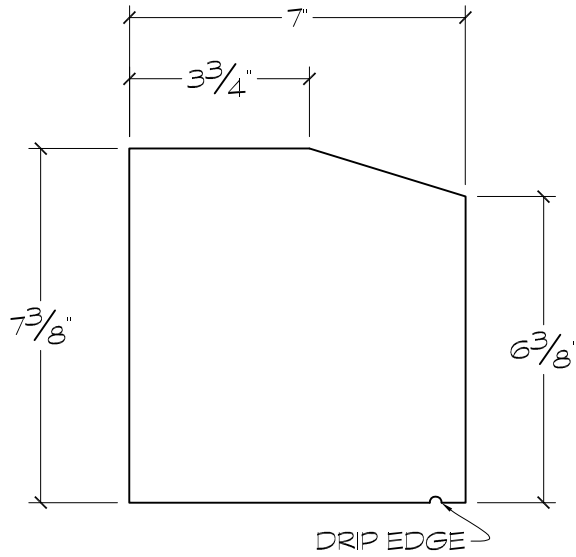

CROSS SECTION

1 **PROFILE EY**
 ARCH REF:
 SCALE: 3"=1'-0"

CAN BE USED AS CORNICE WITH CHAMFER AT BOTTOM EDGE

Profile ID

EY

SUGGESTED USE

Sill	X
Transition Band	X
Coping	
Cap	X
Band	X
Cornice	X

TYPE / SIZE AVAILABILITY

TYPE	LENGTH(S)
Straight	23 5/8"
Left End Return	Up to 29 1/16"
Right End Return	Up to 29 1/16"

TOP VIEWS

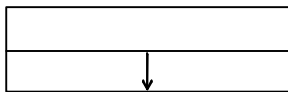

STRAIGHT

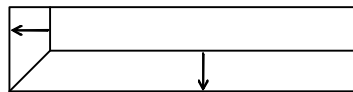

LEFT END RETURN

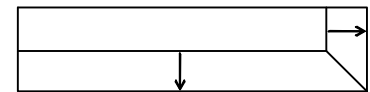

RIGHT END RETURN

DRIP EDGE - OPTIONAL

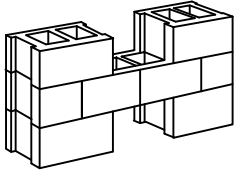

Harvey Cement Products, Inc.

Since 1947

16030 Park Avenue, Harvey, IL 60426

Ph: 708.333.1900 F: 708.333.1910

www.harveycement.com

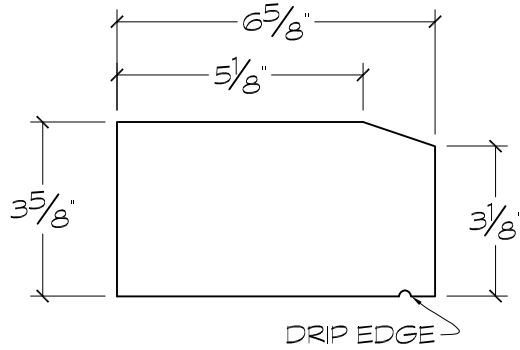

CROSS SECTION

① **PROFILE GB**

ARCH REF:
SCALE: 3"=1'-0"

CAN BE USED AS CORNICE WITH CHAMFER AT BOTTOM EDGE

Profile ID

GB

SUGGESTED USE

Sill	×
Transition Band	×
Coping	
Cap	×
Band	×
Cornice	×

TYPE / SIZE AVAILABILITY

TYPE	LENGTH(S)
Straight	23 5/8"
Left End Return	25 1/8"
Right End Return	25 1/8"

TOP VIEWS

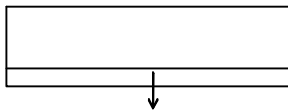

STRAIGHT

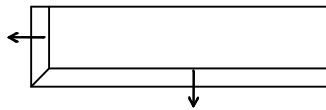

LEFT END RETURN

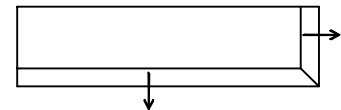

RIGHT END RETURN

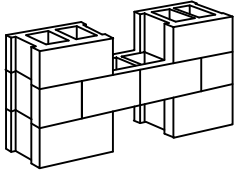

Harvey Cement Products, Inc.

Since 1947

16030 Park Avenue, Harvey, IL 60426

Ph: 708.333.1900 F: 708.333.1910

www.harveycement.com

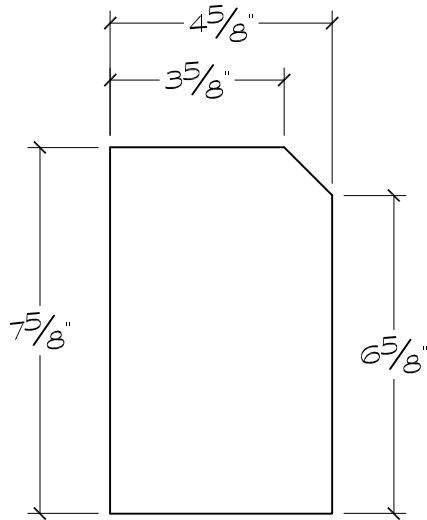

CROSS SECTION

1 **PROFILE GF**
 ARCH REF:
 SCALE: 3"=1'-0"

CAN BE USED AS CORNICE WITH CHAMFER AT BOTTOM EDGE

Profile ID

GF

SUGGESTED USE

Sill	X
Transition Band	X
Coping	
Cap	X
Band	X
Cornice	X

TYPE / SIZE AVAILABILITY

TYPE	LENGTH(S)
Straight	Up to 35 5/8"
Left End Return	Up to 35 13/16"
Right End Return	Up to 35 13/16"

TOP VIEWS



STRAIGHT



LEFT END RETURN



RIGHT END RETURN

DRIP EDGE - OPTIONAL

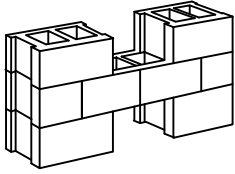

Harvey Cement Products, Inc.

Since 1947

16030 Park Avenue, Harvey, IL 60426

Ph: 708.333.1900 F: 708.333.1910

www.harveycement.com

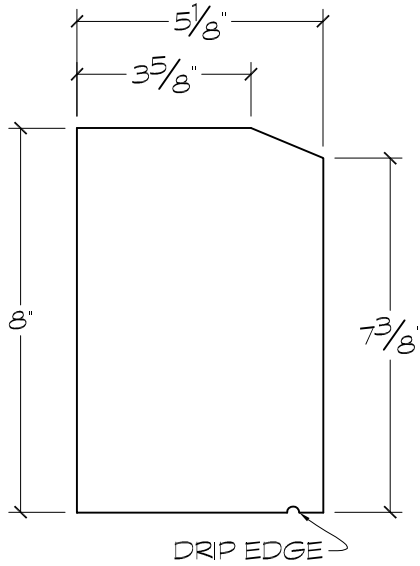

CROSS SECTION

1 **PROFILE GG**
 ARCH REF:
 SCALE: 3"=1'-0"

CAN BE USED AS CORNICE WITH CHAMFER AT BOTTOM EDGE

Profile ID

GG

SUGGESTED USE

Sill	X
Transition Band	
Coping	
Cap	
Band	X
Cornice	X

TYPE / SIZE AVAILABILITY

TYPE	LENGTH(S)
Straight	Up to 23 5/8"
Left End Return	Up to 29 1/8"
Right End Return	Up to 29 1/8"

TOP VIEWS

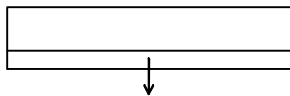

STRAIGHT

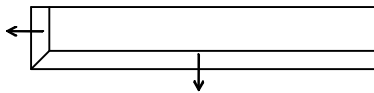

LEFT END RETURN

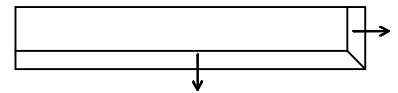

RIGHT END RETURN

DRIP EDGE - OPTIONAL

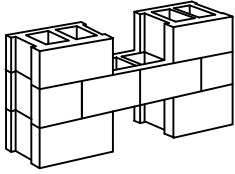

Harvey Cement Products, Inc.

Since 1947

16030 Park Avenue, Harvey, IL 60426

Ph: 708.333.1900 F: 708.333.1910

www.harveycement.com

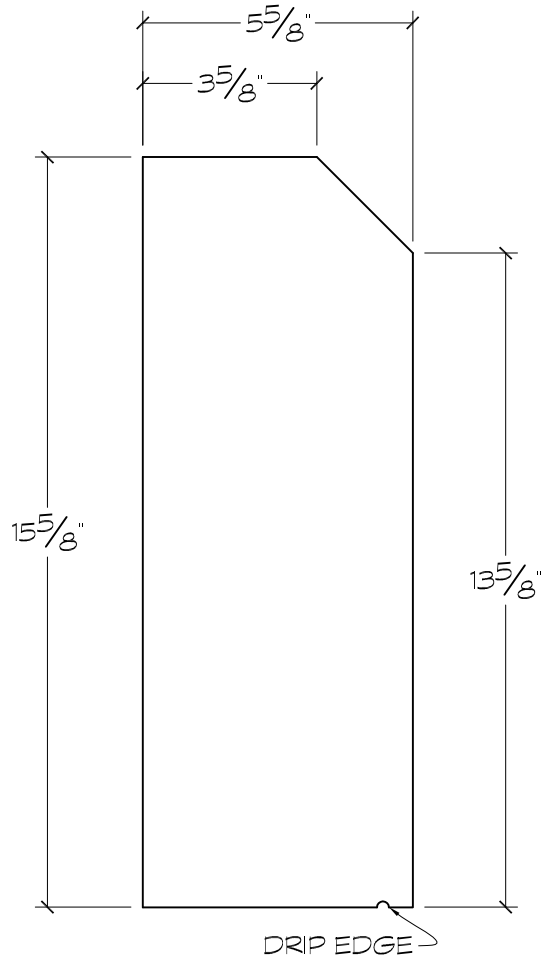

CROSS SECTION

1 **PROFILE GJ**

ARCH REF:
SCALE: 3"=1'-0"

TOP VIEWS

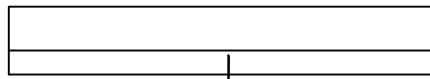

STRAIGHT

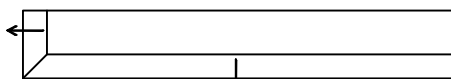

LEFT END RETURN

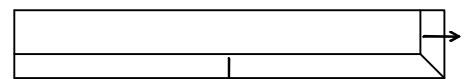

RIGHT END RETURN

Profile ID

GJ

SUGGESTED USE

Sill	
Transition Band	X
Coping	
Cap	
Band	X
Cornice	

**TYPE / SIZE
AVAILABILITY**

TYPE	LENGTH(S)
Straight	35 5/8"
Left End Return	35 13/16"
Right End Return	35 13/16"

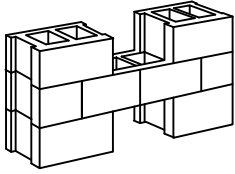

Harvey Cement Products, Inc.

Since 1947

16030 Park Avenue, Harvey, IL 60426

Ph: 708.333.1900 F: 708.333.1910

www.harveycement.com

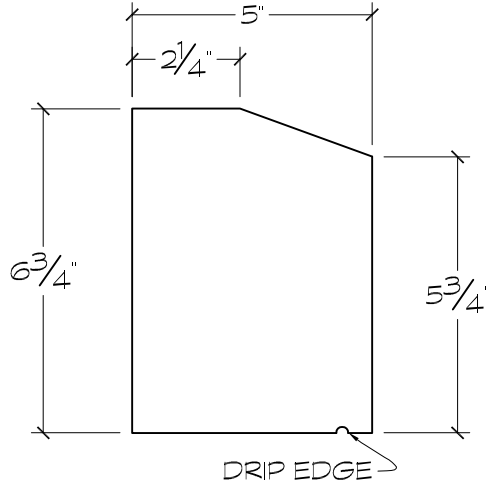

CROSS SECTION

① **PROFILE GR**

ARCH REF:
SCALE: 3"=1'-0"

CAN BE USED AS CORNICE WITH CHAMFER AT BOTTOM EDGE

Profile ID

GR

SUGGESTED USE

Sill	X
Transition Band	X
Coping	
Cap	
Band	X
Cornice	X

TYPE / SIZE AVAILABILITY

TYPE	LENGTH(S)
Straight	Up to 49"
Right End Return	Up to 53 3/6"

TOP VIEWS

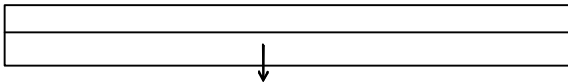

STRAIGHT

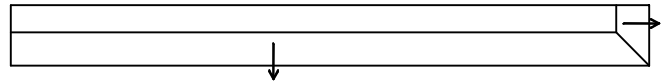

RIGHT END RETURN

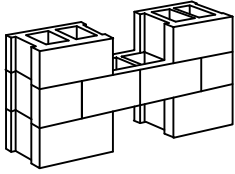

Harvey Cement Products, Inc.

Since 1947

16030 Park Avenue, Harvey, IL 60426

Ph: 708.333.1900 F: 708.333.1910

www.harveycement.com

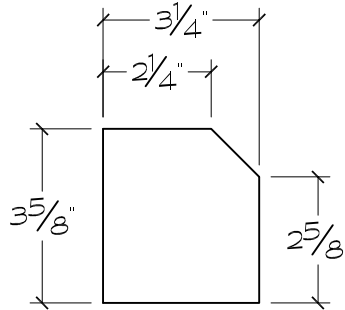

CROSS SECTION

1 **PROFILE GT**

ARCH REF:
SCALE: 3"=1'-0"

CAN BE USED AS CORNICE WITH CHAMFER AT BOTTOM EDGE

Profile ID

GT

SUGGESTED USE

Sill	×
Transition Band	×
Coping	
Cap	
Band	×
Cornice	×

TYPE / SIZE
AVAILABILITY

TYPE	LENGTH(S)
Straight	23 5/8"
Left End Return	24 5/8"
Right End Return	24 5/8"

TOP VIEWS

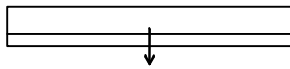

STRAIGHT

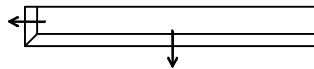

LEFT END RETURN

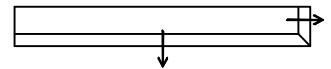

RIGHT END RETURN

DRIP EDGE - OPTIONAL

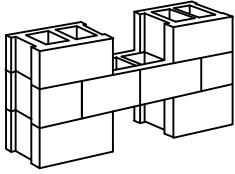

Harvey Cement Products, Inc.

Since 1947

16030 Park Avenue, Harvey, IL 60426

Ph: 708.333.1900 F: 708.333.1910

www.harveycement.com

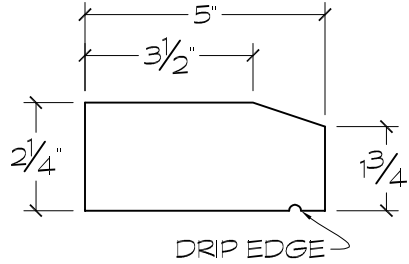

CROSS SECTION

1 PROFILE HD
 ARCH REF:
 SCALE: 3"=1'-0"

Profile ID

HD

SUGGESTED USE

Sill	X
Transition Band	
Coping	
Cap	
Field / Band	
Cornice	

**TYPE / SIZE
 AVAILABILITY**

TYPE	LENGTH(S)
Straight	Up to 24 ³ / ₁₆ "

DRIP EDGE - OPTIONAL

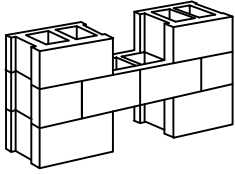

Harvey Cement Products, Inc.

Since 1947

16030 Park Avenue, Harvey, IL 60426

Ph: 708.333.1900 F: 708.333.1910

www.harveycement.com

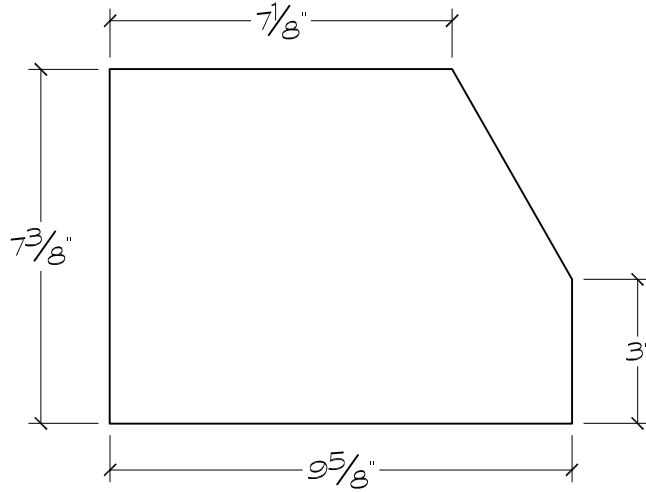

CROSS SECTION

① **PROFILE HH**
 ARCH REF:
 SCALE: 3"=1'-0"

Profile ID

HH

SUGGESTED USE

Sill	×
Transition Band	×
Coping	
Cap	×
Band	×
Cornice	

**TYPE / SIZE
 AVAILABILITY**

TYPE	LENGTH(S)
Straight	Up to 27 7/16"
Left End Return	Up to 34 7/8"
Right End Return	Up to 34 7/8"

TOP VIEWS

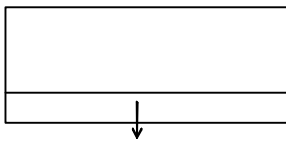

STRAIGHT

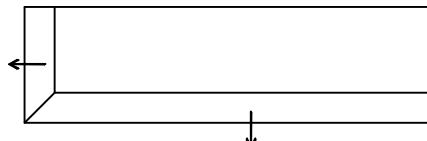

LEFT END RETURN

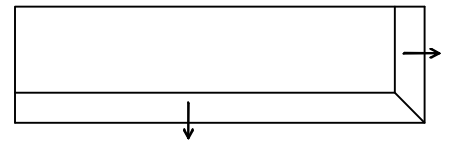

RIGHT END RETURN

DRIP EDGE - OPTIONAL

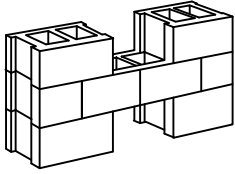

Harvey Cement Products, Inc.

Since 1947

16030 Park Avenue, Harvey, IL 60426

Ph: 708.333.1900 F: 708.333.1910

www.harveycement.com

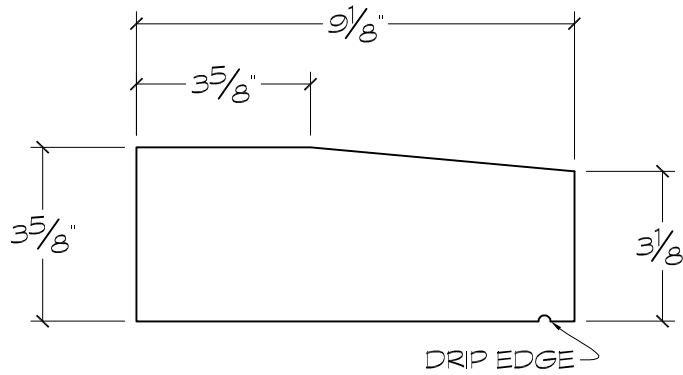

CROSS SECTION

1 PROFILE HK
 ARCH REF:
 SCALE: 3"=1'-0"

Profile ID

HK

SUGGESTED USE

Sill	X
Transition Band	X
Coping	
Cap	
Band	
Cornice	

TYPE / SIZE
 AVAILABILITY

TYPE	LENGTH(S)
Straight	Up to 50 7/16"

DRIP EDGE - OPTIONAL

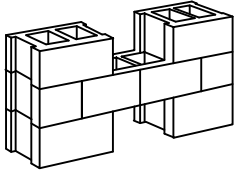

Harvey Cement Products, Inc.

Since 1947

16030 Park Avenue, Harvey, IL 60426

Ph: 708.333.1900 F: 708.333.1910

www.harveycement.com

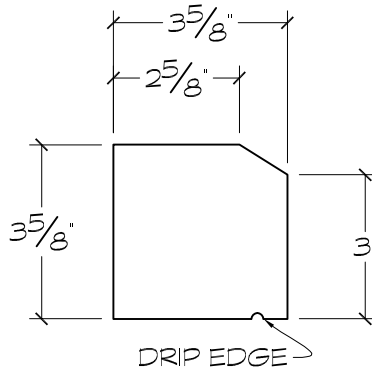

CROSS SECTION

1 PROFILE HR
 ARCH REF:
 SCALE: 3"=1'-0"

TOP VIEWS

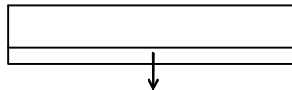

STRAIGHT

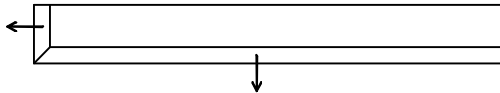

LEFT END RETURN

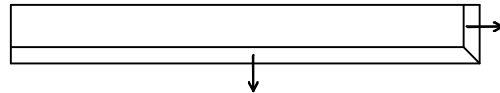

RIGHT END RETURN

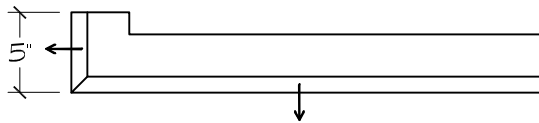

LEFT END RETURN - CUST

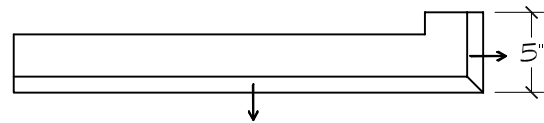

RIGHT END RETURN - CUST

DRIP EDGE - OPTIONAL

Profile ID

HR

SUGGESTED USE

Sill	X
Transition Band	X
Coping	
Cap	X
Band	X
Field	

TYPE / SIZE AVAILABILITY

TYPE	LENGTH(S)
Straight	23 5/8"
Left End Return	Up to 29 5/16"
Right End Return	Up to 29 5/16"
LER - Custom	Up to 29 5/16"
RER - Cust	Up to 29 5/16"

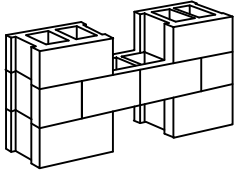

Harvey Cement Products, Inc.

Since 1947

16030 Park Avenue, Harvey, IL 60426

Ph: 708.333.1900 F: 708.333.1910

www.harveycement.com

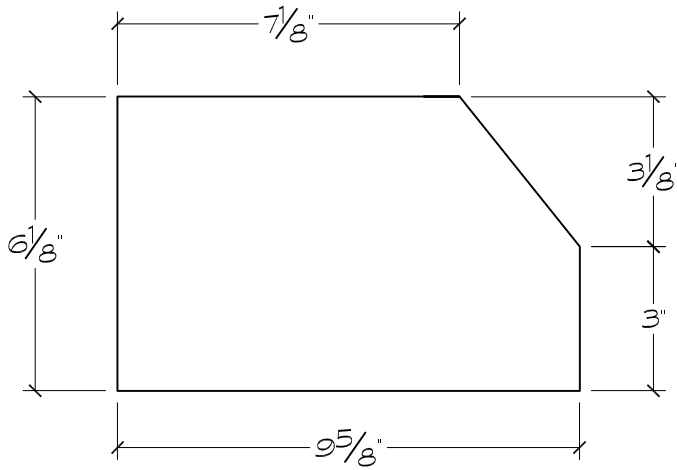

CROSS SECTION

1 PROFILE HS
 ARCH REF:
 SCALE: 3"=1'-0"

TOP VIEWS

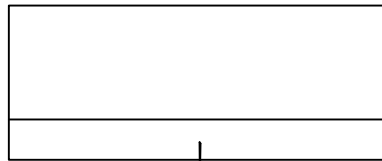

STRAIGHT

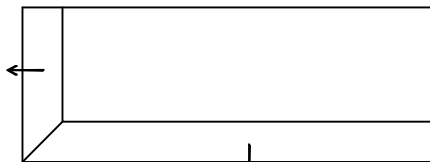

LEFT END RETURN

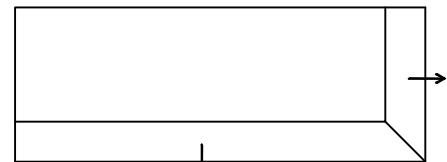

RIGHT END RETURN

DRIP EDGE - OPTIONAL

Profile ID

HS

SUGGESTED USE

Sill	×
Transition Band	×
Coping	
Cap	×
Band	×
Field	
Cornice	

TYPE / SIZE AVAILABILITY

TYPE	LENGTH(S)
Straight	23 ⁵ / ₈ "
Left End Return	25 ⁵ / ₈ "
Right End Return	25 ⁵ / ₈ "

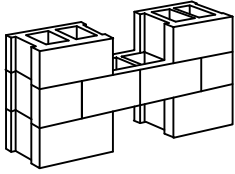

Harvey Cement Products, Inc.

Since 1947

16030 Park Avenue, Harvey, IL 60426

Ph: 708.333.1900 F: 708.333.1910

www.harveycement.com

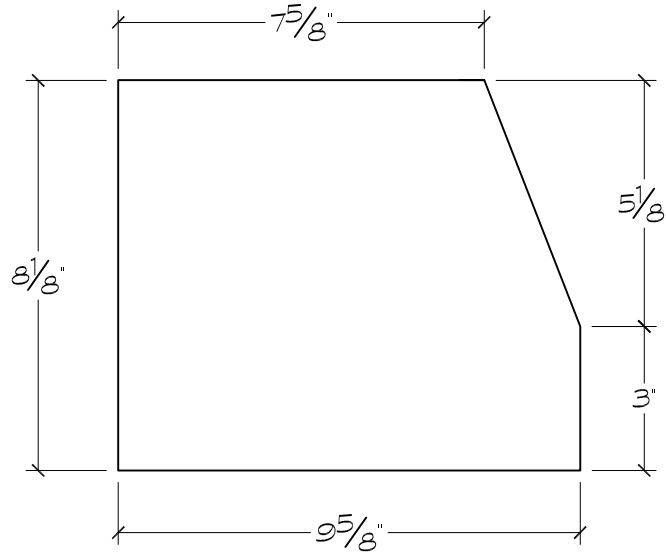

CROSS SECTION

① **PROFILE HT**
 ARCH REF:
 SCALE: 3"=1'-0"

Profile ID

HT

SUGGESTED USE

Sill	×
Transition Band	×
Coping	
Cap	×
Band	×
Field	
Cornice	

TYPE / SIZE AVAILABILITY

TYPE	LENGTH(S)
Straight	23 5/8"
Left End Return	23 3/4"
Right End Return	23 3/4"

TOP VIEWS

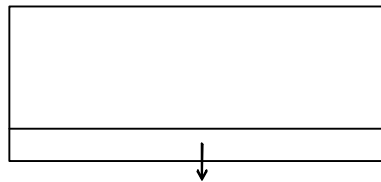

STRAIGHT

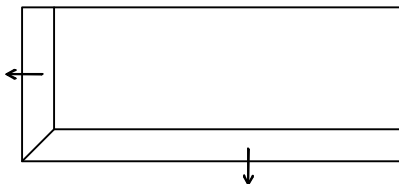

LEFT END RETURN

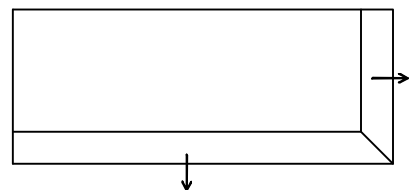

RIGHT END RETURN

DRIP EDGE - OPTIONAL

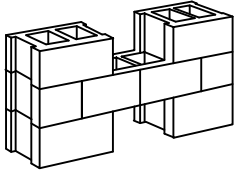

Harvey Cement Products, Inc.

Since 1947

16030 Park Avenue, Harvey, IL 60426

Ph: 708.333.1900 F: 708.333.1910

www.harveycement.com

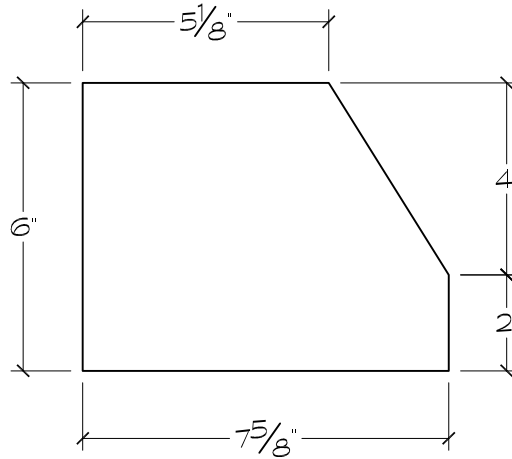

CROSS SECTION

1 **PROFILE HW**

ARCH REF:
SCALE: 3"=1'-0"

Profile ID

HW

SUGGESTED USE

Sill	×
Transition Band	×
Coping	
Cap	×
Band	×
Field	
Cornice	

TYPE / SIZE AVAILABILITY

TYPE	LENGTH(S)
Straight	23 5/8"
Left End Return	Up to 31 5/8"
Right End Return	Up to 31 5/8"

TOP VIEWS

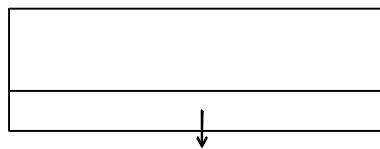

STRAIGHT

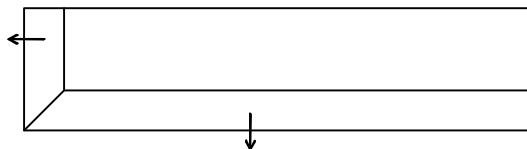

LEFT END RETURN

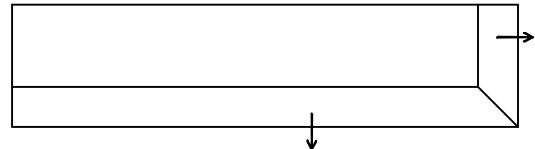

RIGHT END RETURN

DRIP EDGE - OPTIONAL

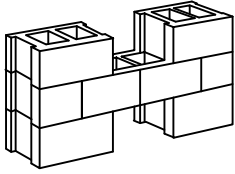

Harvey Cement Products, Inc.

Since 1947

16030 Park Avenue, Harvey, IL 60426

Ph: 708.333.1900 F: 708.333.1910

www.harveycement.com

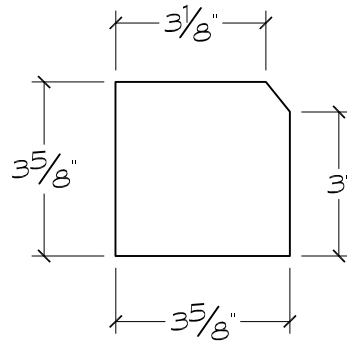

CROSS SECTION

1 **PROFILE HZ**

ARCH REF:
SCALE: 3"=1'-0"

TOP VIEWS

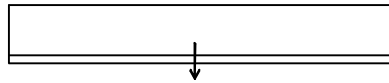

STRAIGHT



LEFT END RETURN

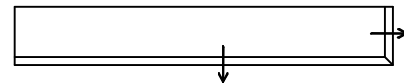

RIGHT END RETURN

DRIP EDGE - OPTIONAL

Profile ID

HZ

SUGGESTED USE

Sill	
Transition Band	X
Coping	
Cap	
Band	X
Field	

TYPE / SIZE
AVAILABILITY

TYPE	LENGTH(S)
Straight	23 ⁵ / ₈ "
Left End Return	23 ⁵ / ₈ "
Right End Return	23 ⁵ / ₈ "



Harvey Cement Products, Inc.

Since 1947

16030 Park Avenue, Harvey, IL 60426

Ph: 708.333.1900 F: 708.333.1910

www.harveycement.com

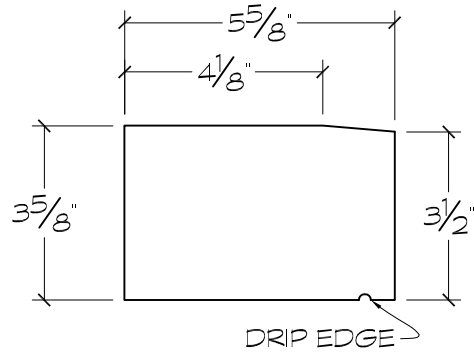

CROSS SECTION

1 **PROFILE JA**
ARCH REF:
SCALE: 3"=1'-0"

TOP VIEWS

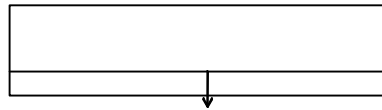

STRAIGHT



LEFT END RETURN

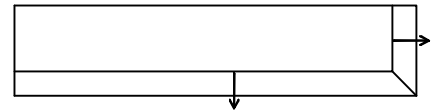

RIGHT END RETURN

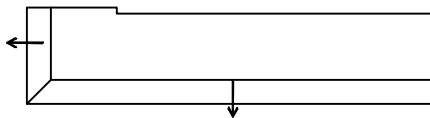

CUSTOM LEFT RETURN

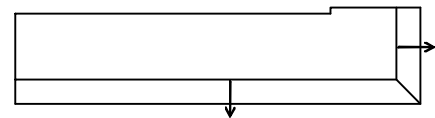

CUSTOM RIGHT RETURN

DRIP EDGE - OPTIONAL

Profile ID

JA

SUGGESTED USE

Sill	×
Transition Band	
Coping	
Cap	×
Band	×
Field	

TYPE / SIZE AVAILABILITY

TYPE	LENGTH(S)
Straight	23 ⁵ / ₈ "
Left End Return	25 ⁵ / ₈ "
Right End Return	25 ⁵ / ₈ "
Custom Left Ret.	Up to 25 ⁵ / ₈ "
Custom Right Ret.	Up to 25 ⁵ / ₈ "

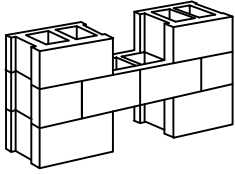

Harvey Cement Products, Inc.

Since 1947

16030 Park Avenue, Harvey, IL 60426

Ph: 708.333.1900 F: 708.333.1910

www.harveycement.com

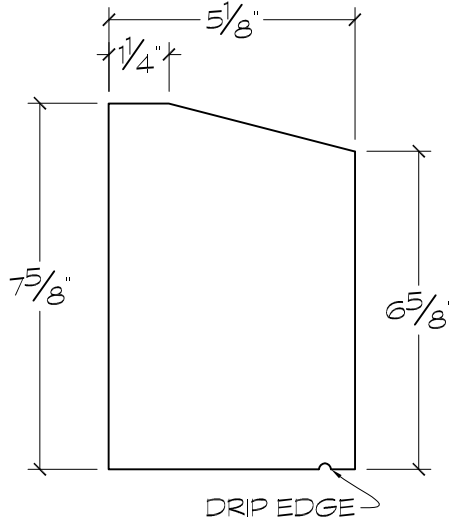

CROSS SECTION

1 **PROFILE JC**
 ARCH REF:
 SCALE: 3"=1'-0"

TOP VIEWS

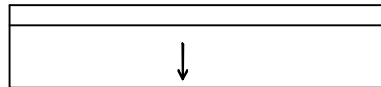

STRAIGHT

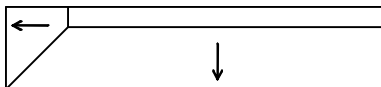

LEFT END RETURN

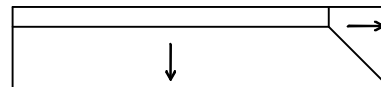

RIGHT END RETURN

DRIP EDGE - OPTIONAL

Profile ID

JC

SUGGESTED USE

Sill	×
Transition Band	×
Coping	
Cap	×
Band	
Field	

TYPE / SIZE AVAILABILITY

TYPE	LENGTH(S)
Straight	23 ⁵ / ₈ "
Left End Return	23 ⁵ / ₈ "
Right End Return	23 ⁵ / ₈ "

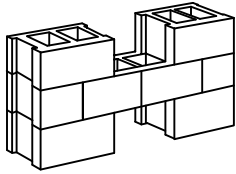

Harvey Cement Products, Inc.

Since 1947

16030 Park Avenue, Harvey, IL 60426

Ph: 708.333.1900 F: 708.333.1910

www.harveycement.com

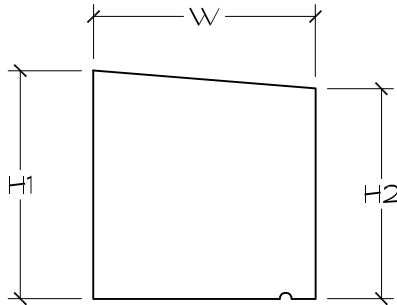

PROFILE TYPE:

SILL

SURFACE FINISH:

SMOOTH

REFER TO
INDIVIDUAL
PROFILE (ID) PAGES
FOR DETAILS
AND LENGTHS
AVAILABLE.

	W	H1	H2	ID
	4 5/8"	4 3/4"	4 3/8"	BV
	5 5/8"	7 5/8"	7"	HC
	5 7/8"	7 1/8"	6"	GA
	6 1/8"	3 5/8"	3 1/8"	GS
	6 5/8"	7 5/8"	7"	HB
	8 5/8"	7 5/8"	7 1/8"	DZ
	20 1/2"	6 5/8"	4 5/8"	GH

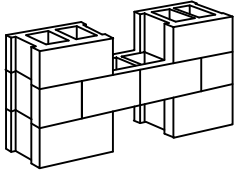

Harvey Cement Products, Inc.

Since 1947

16030 Park Avenue, Harvey, IL 60426

Ph: 708.333.1900 F: 708.333.1910

www.harveycement.com

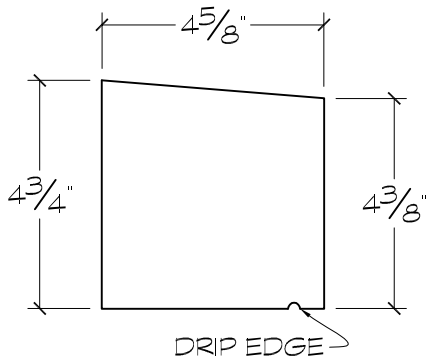

CROSS SECTION

1 **PROFILE BV**
 ARCH REF:
 SCALE: 3"=1'-0"

Profile ID

BV

SUGGESTED USE

Sill	X
Transition Band	
Coping	
Cap	
Field / Band	
Cornice	

**TYPE / SIZE
 AVAILABILITY**

TYPE	LENGTH(S)
Straight	Up to 37 ¹ / ₆ "

DRIP EDGE - OPTIONAL

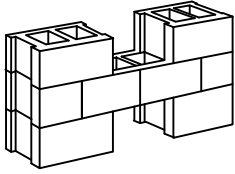

Harvey Cement Products, Inc.

Since 1947

16030 Park Avenue, Harvey, IL 60426

Ph: 708.333.1900 F: 708.333.1910

www.harveycement.com

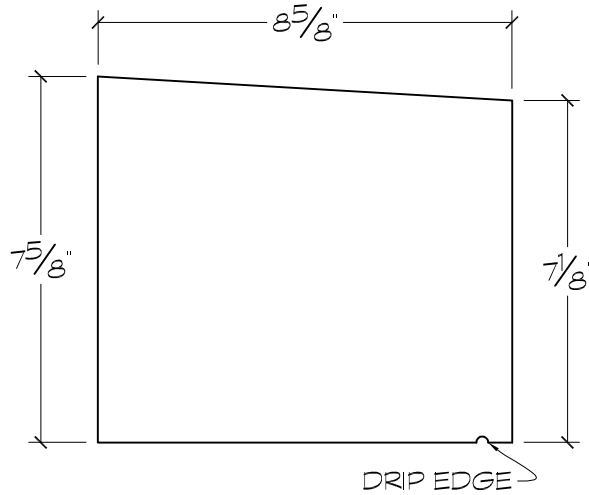

CROSS SECTION

1 **PROFILE DZ**
 ARCH REF:
 SCALE: 3"=1'-0"

Profile ID

DZ

SUGGESTED USE

Sill	
Transition Band	
Coping	
Cap	X
Field / Band	
Cornice	

TYPE / SIZE AVAILABILITY

TYPE	LENGTH(S)
Straight	23 5/8"
Left End Return	25 1/2"
Right End Return	25 1/2"

TOP VIEWS

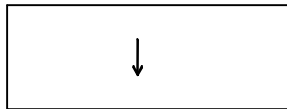

STRAIGHT

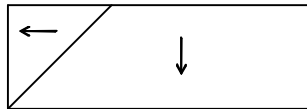

LEFT END RETURN

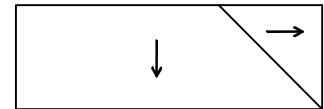

RIGHT END RETURN

DRIP EDGE - OPTIONAL

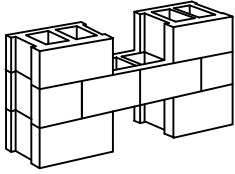

Harvey Cement Products, Inc.

Since 1947

16030 Park Avenue, Harvey, IL 60426

Ph: 708.333.1900 F: 708.333.1910

www.harveycement.com

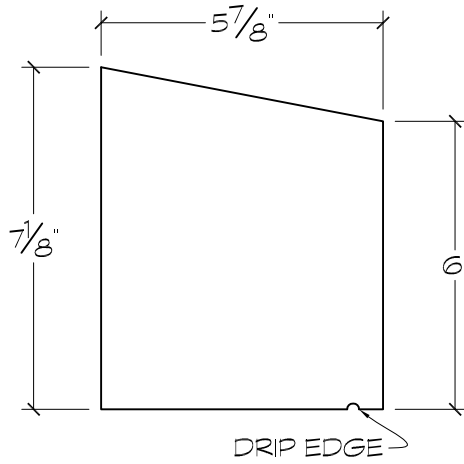

CROSS SECTION

① **PROFILE GA**
 ARCH REF:
 SCALE: 3"=1'-0"

Profile ID

GA

SUGGESTED USE

Sill	X
Transition Band	
Coping	
Cap	X
Field / Band	
Cornice	

TYPE / SIZE AVAILABILITY

TYPE	LENGTH(S)
Straight	23 5/8"
Left End Return	Up to 29 5/6"
Right End Return	Up to 29 5/6"

FRONT VIEWS

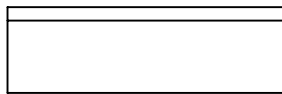

STRAIGHT

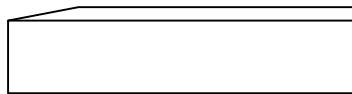

LEFT END RETURN

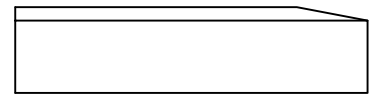

RIGHT END RETURN

DRIP EDGE - OPTIONAL

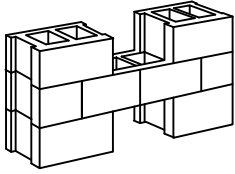

Harvey Cement Products, Inc.

Since 1947

16030 Park Avenue, Harvey, IL 60426

Ph: 708.333.1900 F: 708.333.1910

www.harveycement.com

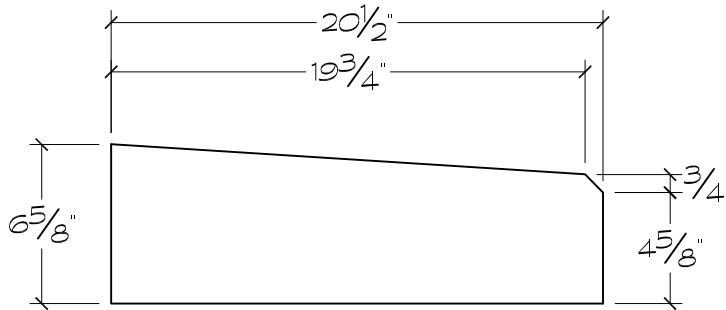

CROSS SECTION

1 **PROFILE GH**
 ARCH REF:
 SCALE: 1 1/2"=1'-0"

Profile ID

GH

SUGGESTED USE

Sill	X
Transition Band	
Coping	
Cap	
Field / Band	
Cornice	

TYPE / SIZE
 AVAILABILITY

TYPE	LENGTH(S)
Straight	Up to 21 1/8"

DRIP EDGE - OPTIONAL

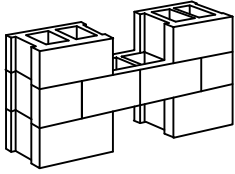

Harvey Cement Products, Inc.

Since 1947

16030 Park Avenue, Harvey, IL 60426

Ph: 708.333.1900 F: 708.333.1910

www.harveycement.com

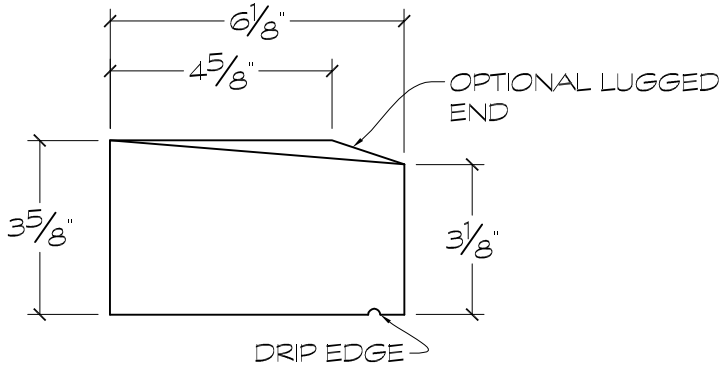

CROSS SECTION

1 PROFILE GS

ARCH REF:
SCALE: 3"=1'-0"

Profile ID

GS

SUGGESTED USE

Sill	X
Transition Band	
Coping	
Cap	
Field / Band	
Cornice	

TYPE / SIZE AVAILABILITY

TYPE	LENGTH(S)
Straight	Up to 47 ¹⁵ / ₁₆ "
Lug - Left End	Up to 53 ³ / ₁₆ "
Lug - Right End	Up to 53 ³ / ₁₆ "

TOP VIEWS

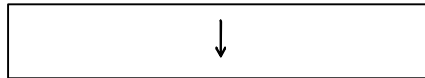

STRAIGHT

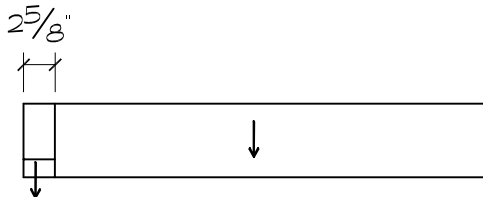

LUG - LEFT END

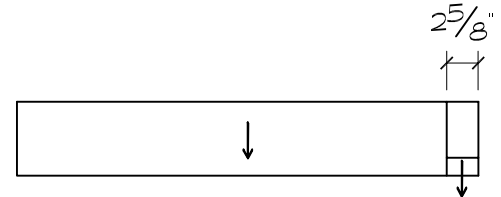

LUG - RIGHT END

DRIP EDGE - OPTIONAL

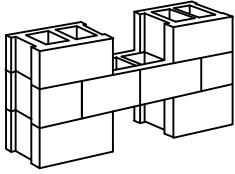

Harvey Cement Products, Inc.

Since 1947

16030 Park Avenue, Harvey, IL 60426

Ph: 708.333.1900 F: 708.333.1910

www.harveycement.com

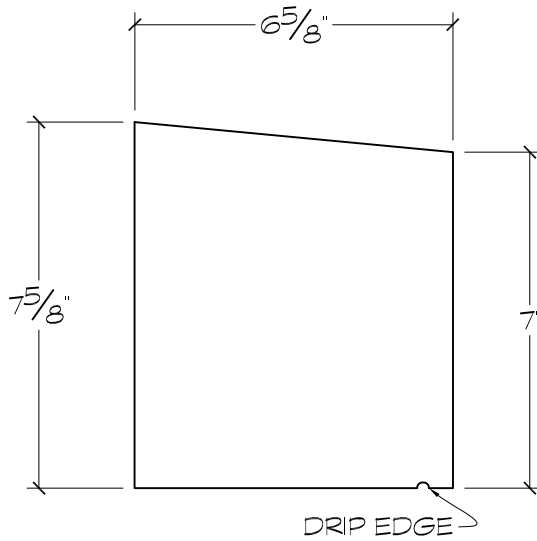

CROSS SECTION

1 **PROFILE HB**
 ARCH REF:
 SCALE: 3"=1'-0"

Profile ID

HB

SUGGESTED USE

Sill	X
Transition Band	
Coping	
Cap	X
Field / Band	
Cornice	

TYPE / SIZE AVAILABILITY

TYPE	LENGTH(S)
Straight	23 5/8"
Left End Return	Up to 31 13/16"
Right End Return	Up to 31 13/16"

TOP VIEWS



STRAIGHT



LEFT END RETURN



RIGHT END RETURN

DRIP EDGE - OPTIONAL

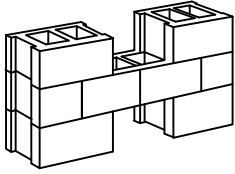

Harvey Cement Products, Inc.

Since 1947

16030 Park Avenue, Harvey, IL 60426

Ph: 708.333.1900 F: 708.333.1910

www.harveycement.com

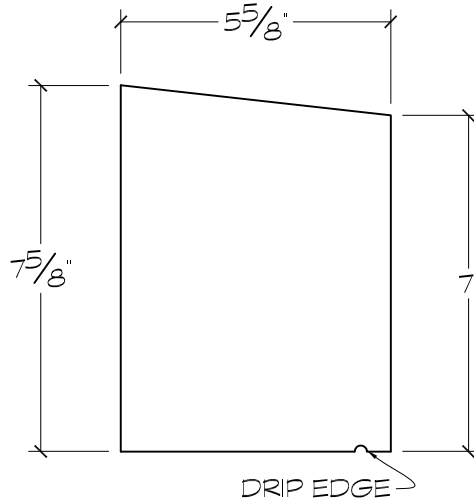

CROSS SECTION

1

PROFILE HC

ARCH REF:

SCALE: 3"=1'-0"

Profile ID

HC

SUGGESTED USE

Sill	X
Transition Band	
Coping	
Cap	
Field / Band	
Cornice	

TYPE / SIZE
AVAILABILITY

TYPE	LENGTH(S)
Straight	23 5/8"

DRIP EDGE - OPTIONAL

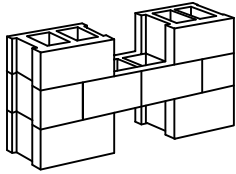

Harvey Cement Products, Inc.

Since 1947

16030 Park Avenue, Harvey, IL 60426

Ph: 708.333.1900 F: 708.333.1910

www.harveycement.com

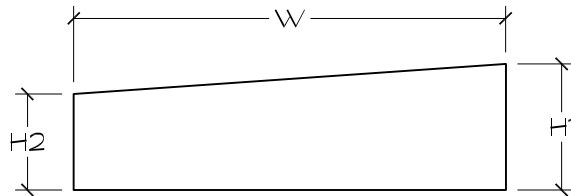

PROFILE TYPE:

**SINGLE PITCH
COPING**

SURFACE FINISH:

SMOOTH

REFER TO
INDIVIDUAL
PROFILE (ID) PAGES
FOR DETAILS
AND LENGTHS
AVAILABLE.

	W	H1	H2	ID
	6 5/8"	2 3/8"	1 1/2"	BY
	8"	2 5/8"	2"	CC
	8 3/4"	3 5/8"	3 1/8"	DL
	9"	2 5/8"	2"	BH
	9"	3 5/8"	3"	P
	10"	3"	2"	CD
	11"	3 5/8"	3 1/8"	T
	11"	4"	3 1/2"	BN
	12"	2 5/8"	2"	GX
	12 1/2"	2 5/8"	2"	CG
	13"	3 1/2"	2 1/2"	D
	14"	2 5/8"	2"	CL
	15"	4"	3 1/4"	AE

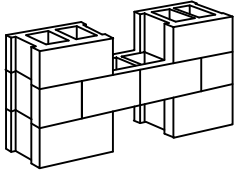

Harvey Cement Products, Inc.

Since 1947

16030 Park Avenue, Harvey, IL 60426

Ph: 708.333.1900 F: 708.333.1910

www.harveycement.com

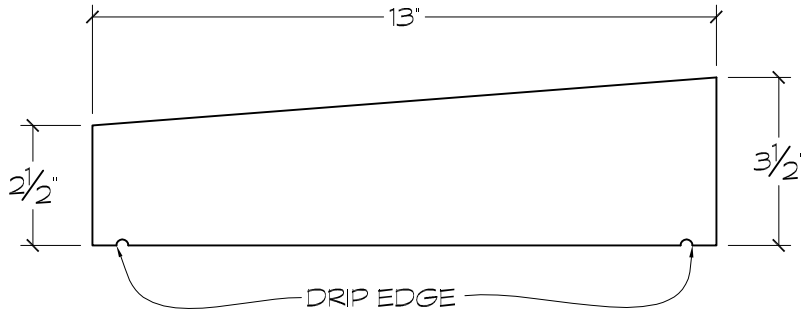

CROSS SECTION

1

PROFILE D

ARCH REF:
SCALE: 3"=1'-0"

Profile ID

D

SUGGESTED USE

Sill	X
Transition Band	
Coping	X
Cap	X
Field / Band	
Cornice	

TYPE / SIZE AVAILABILITY

TYPE	LENGTH(S)
Straight	23 5/8"
Left End Return	23 5/8"
Right End Return	23 5/8"

TOP VIEWS

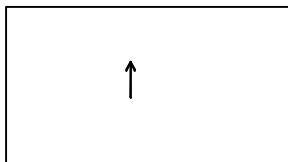

STRAIGHT

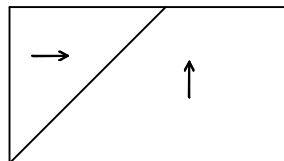

LEFT END RETURN

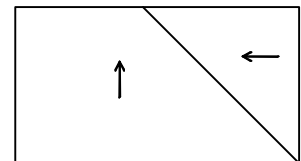

RIGHT END RETURN

DRIP EDGE - OPTIONAL

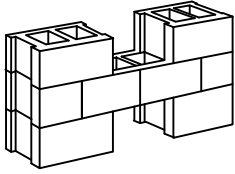

Harvey Cement Products, Inc.

Since 1947

16030 Park Avenue, Harvey, IL 60426

Ph: 708.333.1900 F: 708.333.1910

www.harveycement.com

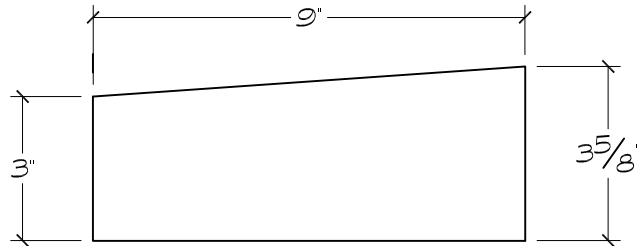

CROSS SECTION

① **PROFILE P**
 ARCH REF:
 SCALE: 3"=1'-0"

Profile ID

P

SUGGESTED USE

Sill	×
Transition Band	
Coping	×
Cap	
Field / Band	
Cornice	

**TYPE / SIZE
 AVAILABILITY**

TYPE	LENGTH(S)
Straight	23 5/8"

DRIP EDGE - OPTIONAL

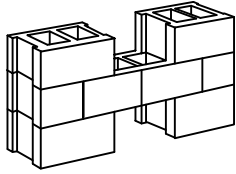

Harvey Cement Products, Inc.

Since 1947

16030 Park Avenue, Harvey, IL 60426

Ph: 708.333.1900 F: 708.333.1910

www.harveycement.com

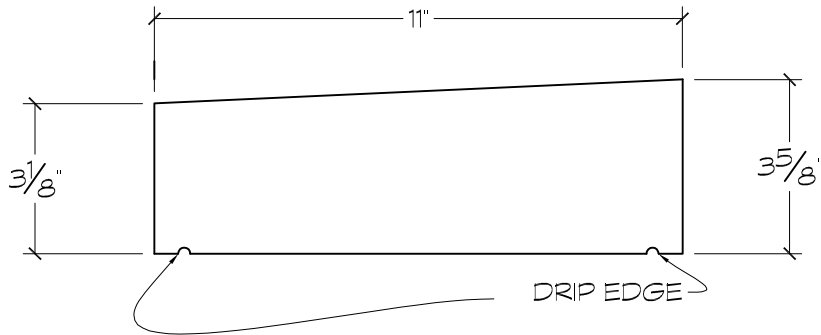

CROSS SECTION

1 **PROFILE T**
 ARCH REF:
 SCALE: 3"=1'-0"

Profile ID

T

SUGGESTED USE

Sill	X
Transition Band	
Coping	X
Cap	X
Field / Band	
Cornice	

TYPE / SIZE AVAILABILITY

TYPE	LENGTH(S)
Straight	35 5/8"
Left End Return	36 5/8"
Right End Return	36 5/8"

TOP VIEWS

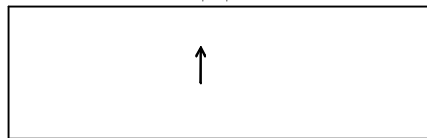

STRAIGHT

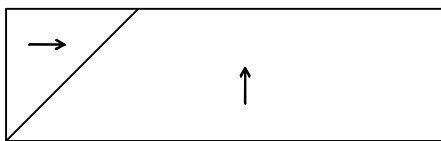

LEFT END RETURN

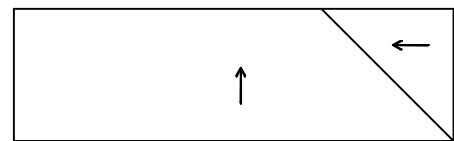

RIGHT END RETURN

DRIP EDGE - OPTIONAL

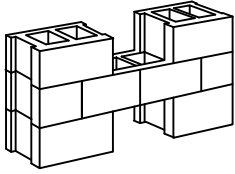

Harvey Cement Products, Inc.

Since 1947

16030 Park Avenue, Harvey, IL 60426

Ph: 708.333.1900 F: 708.333.1910

www.harveycement.com

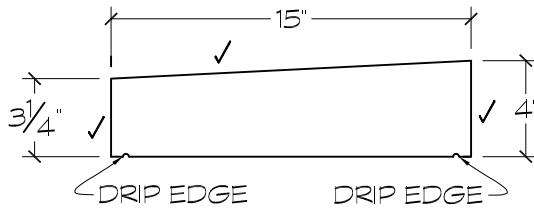

CROSS SECTION

1 **PROFILE AE**
 ARCH REF:
 SCALE: 1-1/2"=1'-0"

Profile ID

AE

SUGGESTED USE

Sill	X
Transition Band	
Coping	X
Cap	X
Field / Band	
Cornice	

TYPE / SIZE AVAILABILITY

TYPE	LENGTH(S)
Straight	Up to 47 5/8"
Left End Return	Up to 47 5/8"
Right End Return	Up to 47 5/8"

TOP VIEWS

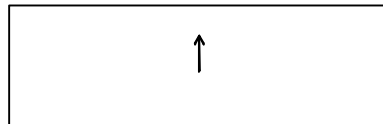

STRAIGHT

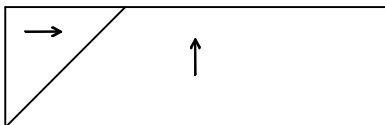

LEFT END RETURN

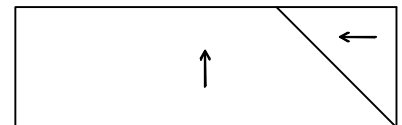

RIGHT END RETURN

DRIP EDGE - OPTIONAL

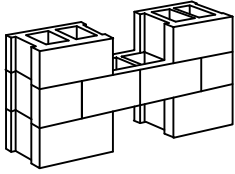

Harvey Cement Products, Inc.

Since 1947

16030 Park Avenue, Harvey, IL 60426

Ph: 708.333.1900 F: 708.333.1910

www.harveycement.com

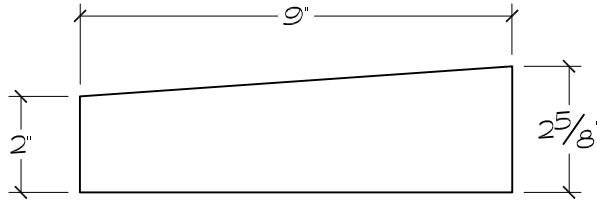

CROSS SECTION

① **PROFILE BH**

ARCH REF:

SCALE: 3"=1'-0"

Profile ID

BH

SUGGESTED USE

Sill	X
Transition Band	
Coping	X
Cap	X
Field / Band	
Cornice	

TYPE / SIZE AVAILABILITY

TYPE	LENGTH(S)
Straight	Up to 25 5/8"
Left End Return	Up to 26 5/8"
Right End Return	Up to 26 5/8"

TOP VIEWS

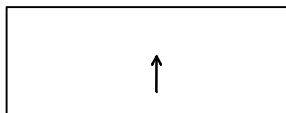

STRAIGHT

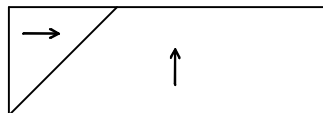

LEFT END RETURN

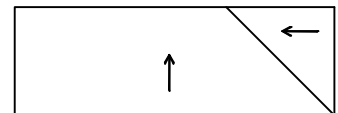

RIGHT END RETURN

DRIP EDGE - OPTIONAL

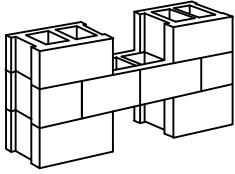

Harvey Cement Products, Inc.

Since 1947

16030 Park Avenue, Harvey, IL 60426

Ph: 708.333.1900 F: 708.333.1910

www.harveycement.com

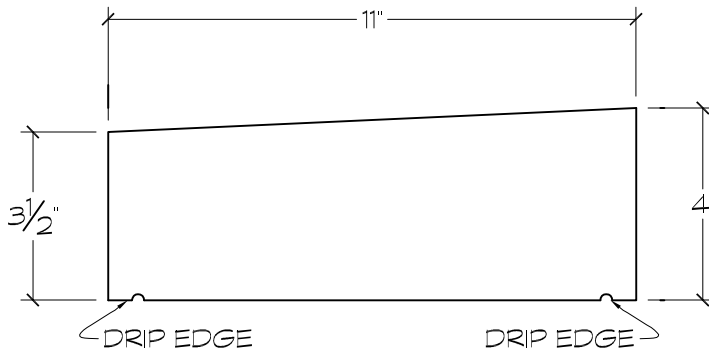

CROSS SECTION

1 **PROFILE BN**
 ARCH REF:
 SCALE: 3"=1'-0"

Profile ID

BN

SUGGESTED USE

Sill	X
Transition Band	
Coping	X
Cap	X
Field / Band	
Cornice	

TYPE / SIZE AVAILABILITY

TYPE	LENGTH(S)
Straight	Up to 35 5/8"
Left End Return	Up to 36 5/8"
Right End Return	Up to 36 5/8"

TOP VIEWS

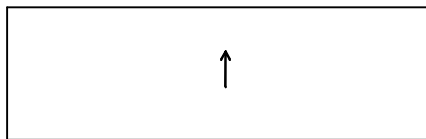

STRAIGHT

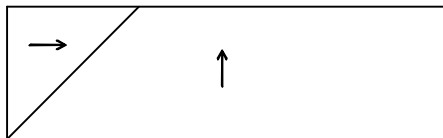

LEFT END RETURN

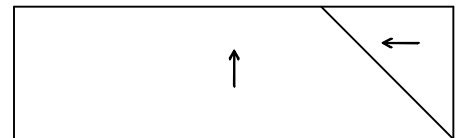

RIGHT END RETURN

DRIP EDGE - OPTIONAL

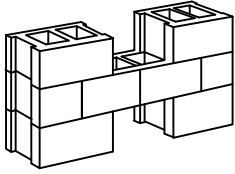

Harvey Cement Products, Inc.

Since 1947

16030 Park Avenue, Harvey, IL 60426

Ph: 708.333.1900 F: 708.333.1910

www.harveycement.com

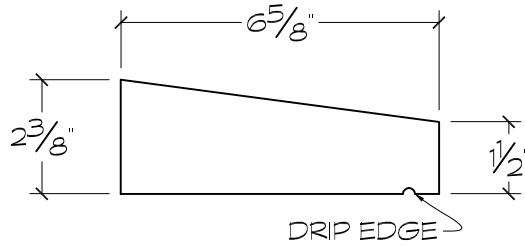

CROSS SECTION

1 **PROFILE BY**
 ARCH REF:
 SCALE: 3"=1'-0"

Profile ID

BY

SUGGESTED USE

Sill	×
Transition Band	
Coping	×
Cap	×
Field / Band	
Cornice	

**TYPE / SIZE
 AVAILABILITY**

TYPE	LENGTH(S)
Straight	23 5/8"
Left End Return	24 5/8"
Right End Return	24 5/8"

TOP VIEWS

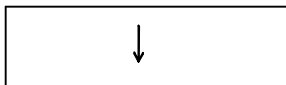

STRAIGHT

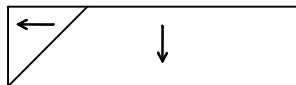

LEFT END RETURN

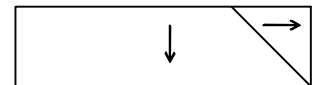

RIGHT END RETURN

DRIP EDGE - OPTIONAL

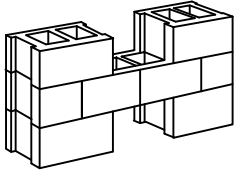

Harvey Cement Products, Inc.

Since 1947

16030 Park Avenue, Harvey, IL 60426

Ph: 708.333.1900 F: 708.333.1910

www.harveycement.com

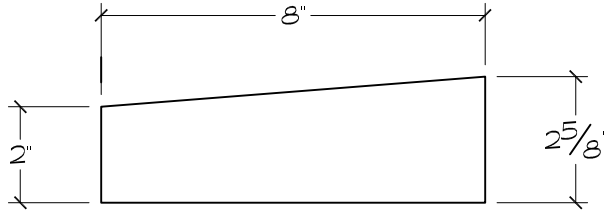

CROSS SECTION

1

PROFILE CC

ARCH REF:
SCALE: 3"=1'-0"

Profile ID

CC

SUGGESTED USE

Sill	X
Transition Band	
Coping	X
Cap	X
Field / Band	
Cornice	

TYPE / SIZE AVAILABILITY

TYPE	LENGTH(S)
Straight	23 5/8"
Left End Return	23 5/8"
Right End Return	23 5/8"

TOP VIEWS



STRAIGHT

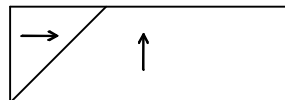

LEFT END RETURN



RIGHT END RETURN

DRIP EDGE - OPTIONAL

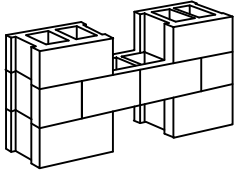

Harvey Cement Products, Inc.

Since 1947

16030 Park Avenue, Harvey, IL 60426

Ph: 708.333.1900 F: 708.333.1910

www.harveycement.com

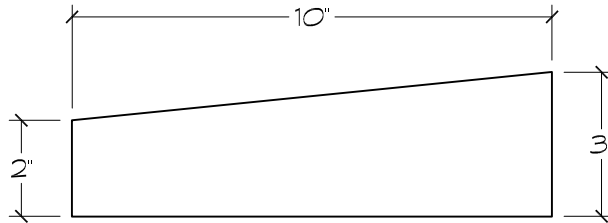

CROSS SECTION

① **PROFILE CD**

ARCH REF:
SCALE: 3"=1'-0"

Profile ID

CD

SUGGESTED USE

Sill	X
Transition Band	
Coping	X
Cap	
Field / Band	
Cornice	

**TYPE / SIZE
AVAILABILITY**

TYPE	LENGTH(S)
Straight	23 5/8"

DRIP EDGE - OPTIONAL

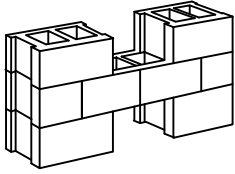

Harvey Cement Products, Inc.

Since 1947

16030 Park Avenue, Harvey, IL 60426

Ph: 708.333.1900 F: 708.333.1910

www.harveycement.com

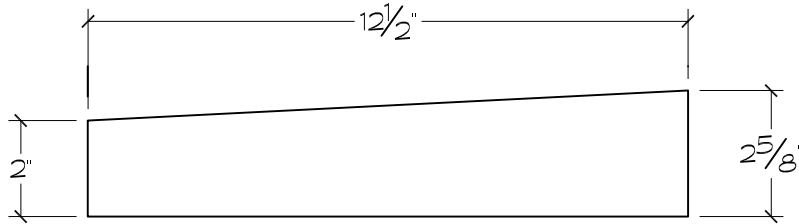

CROSS SECTION

① **PROFILE CG**

ARCH REF:
SCALE: 3"=1'-0"

Profile ID

CG

SUGGESTED USE

Sill	×
Transition Band	
Coping	×
Cap	×
Field / Band	
Cornice	

TYPE / SIZE AVAILABILITY

TYPE	LENGTH(S)
Straight	23 5/8"
Left End Return	23 5/8"
Right End Return	23 5/8"

TOP VIEWS

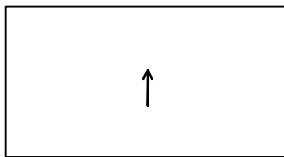

STRAIGHT

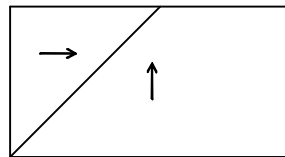

LEFT END RETURN

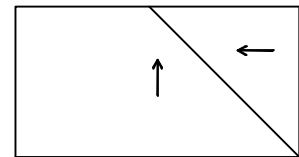

RIGHT END RETURN

DRIP EDGE - OPTIONAL

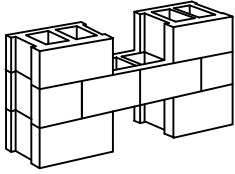

Harvey Cement Products, Inc.

Since 1947

16030 Park Avenue, Harvey, IL 60426

Ph: 708.333.1900 F: 708.333.1910

www.harveycement.com

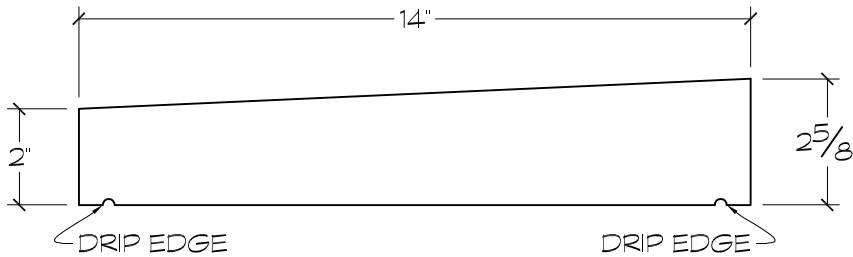

CROSS SECTION

1 **PROFILE CL**
 ARCH REF:
 SCALE: 3"=1'-0"

Profile ID

CL

SUGGESTED USE

Sill	×
Transition Band	
Coping	×
Cap	×
Field / Band	
Cornice	

TYPE / SIZE
 AVAILABILITY

TYPE	LENGTH(S)
Straight	23 5/8"
Left End Return	23 5/8"
Right End Return	23 5/8"

TOP VIEWS

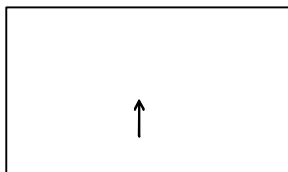

STRAIGHT

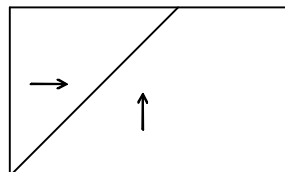

LEFT END RETURN

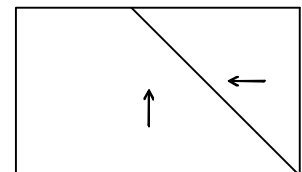

RIGHT END RETURN

DRIP EDGE - OPTIONAL

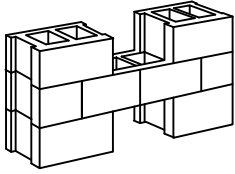

Harvey Cement Products, Inc.

Since 1947

16030 Park Avenue, Harvey, IL 60426

Ph: 708.333.1900 F: 708.333.1910

www.harveycement.com

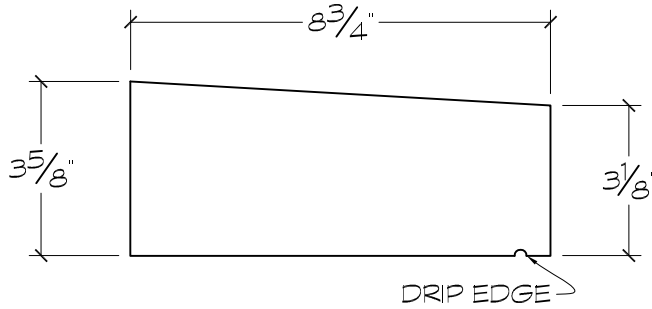

CROSS SECTION

1 **PROFILE DL**

ARCH REF:
SCALE: 3"=1'-0"

Profile ID

DL

SUGGESTED USE

Sill	X
Transition Band	
Coping	X
Cap	
Field / Band	
Cornice	

TYPE / SIZE AVAILABILITY

TYPE	LENGTH(S)
Straight	Up to 34"

DRIP EDGE - OPTIONAL

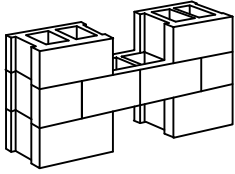

Harvey Cement Products, Inc.

Since 1947

16030 Park Avenue, Harvey, IL 60426

Ph: 708.333.1900 F: 708.333.1910

www.harveycement.com

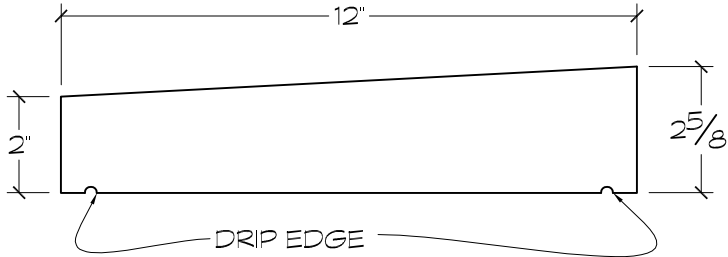

CROSS SECTION

① **PROFILE GX**

ARCH REF:
SCALE: 3"=1'-0"

Profile ID

GX

SUGGESTED USE

Sill	×
Transition Band	
Coping	×
Cap	×
Field / Band	
Cornice	

TYPE / SIZE AVAILABILITY

TYPE	LENGTH(S)
Straight	23 5/8"
Left End Return	23 5/8"
Right End Return	23 5/8"

TOP VIEWS

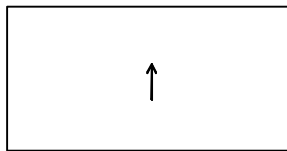

STRAIGHT

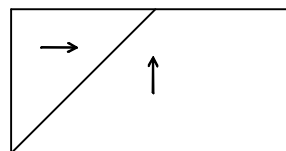

LEFT END RETURN

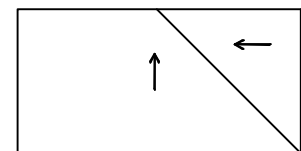

RIGHT END RETURN

DRIP EDGE - OPTIONAL

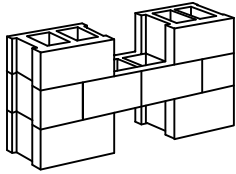

Harvey Cement Products, Inc.

Since 1947

16030 Park Avenue, Harvey, IL 60426

Ph: 708.333.1900 F: 708.333.1910

www.harveycement.com

PROFILE TYPE:

**DOUBLE PITCH
COPING**

SURFACE FINISH:

SMOOTH

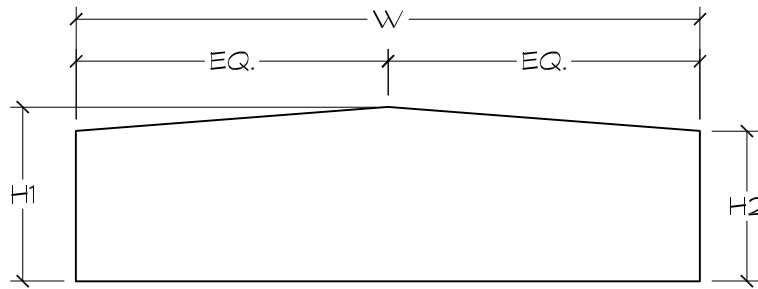

REFER TO
INDIVIDUAL
PROFILE (ID) PAGES
FOR DETAILS
AND LENGTHS
AVAILABLE.

	W	H1	H2	ID
	12"	2 ⁵ / ₈ "	2 ¹ / ₈ "	H
	13"	3 ⁵ / ₈ "	3 ¹ / ₈ "	AR
	13"	7 ⁵ / ₈ "	1 ¹ / ₈ "	AM
	14"	4"	3"	CX
	18"	3 ⁵ / ₈ "	3 ¹ / ₈ "	AK
	18"	4"	3"	DK
	19"	3 ⁵ / ₈ "	3 ¹ / ₈ "	DH
	26"	3 ⁵ / ₈ "	3 ¹ / ₈ "	AJ
	28"	6 ³ / ₄ "	5 ³ / ₄ "	BD

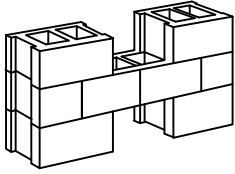

Harvey Cement Products, Inc.

Since 1947

16030 Park Avenue, Harvey, IL 60426

Ph: 708.333.1900 F: 708.333.1910

www.harveycement.com

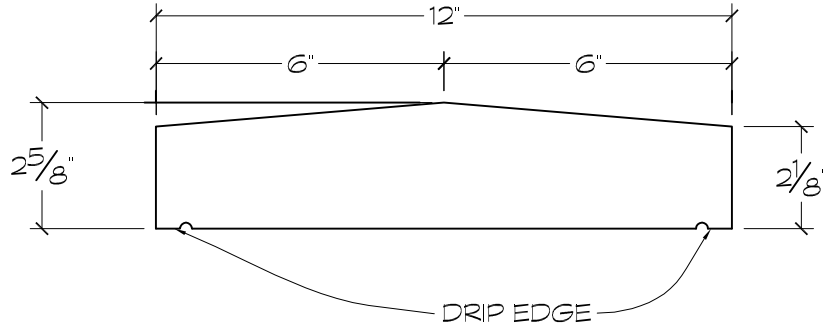

CROSS SECTION

① **PROFILE H**
 ARCH REF:
 SCALE: 3"=1'-0"

Profile ID

H

SUGGESTED USE

Sill	
Transition Band	
Coping	X
Cap	X
Field / Band	
Cornice	

**TYPE / SIZE
 AVAILABILITY**

TYPE	LENGTH(S)
Straight	Up to 25"
End Return	Up to 31"

TOP VIEWS

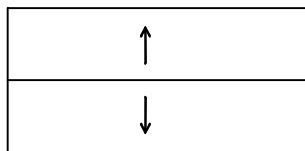

STRAIGHT

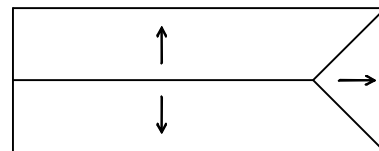

END RETURN

DRIP EDGE - OPTIONAL

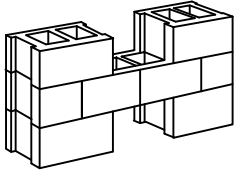

Harvey Cement Products, Inc.

Since 1947

16030 Park Avenue, Harvey, IL 60426

Ph: 708.333.1900 F: 708.333.1910

www.harveycement.com

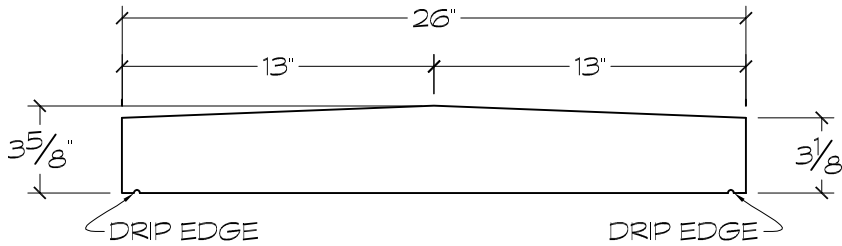

CROSS SECTION

① **PROFILE AJ**
 ARCH REF:
 SCALE: 1-1/2"=1'-0"

Profile ID

AJ

SUGGESTED USE

Sill	
Transition Band	
Coping	X
Cap	X
Field / Band	
Cornice	

TYPE / SIZE AVAILABILITY

TYPE	LENGTH(S)
Straight	Up to 28 1/2"

DRIP EDGE - OPTIONAL

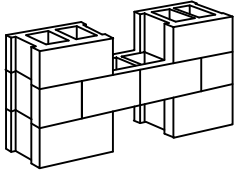

Harvey Cement Products, Inc.

Since 1947

16030 Park Avenue, Harvey, IL 60426

Ph: 708.333.1900 F: 708.333.1910

www.harveycement.com

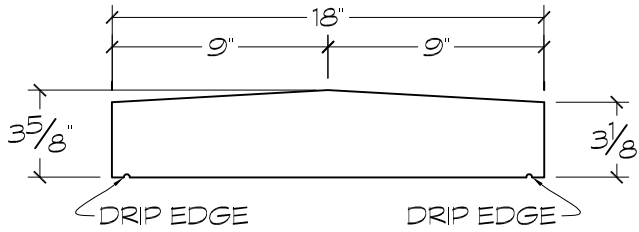

CROSS SECTION

1 **PROFILE AK**
 ARCH REF:
 SCALE: 1-1/2"=1'-0"

Profile ID

AK

SUGGESTED USE

Sill	
Transition Band	
Coping	X
Cap	X
Field / Band	
Cornice	

TYPE / SIZE
 AVAILABILITY

TYPE	LENGTH(S)
Straight	Up to 44 3/8"
Left End Return	
Right End Return	

DRIP EDGE - OPTIONAL

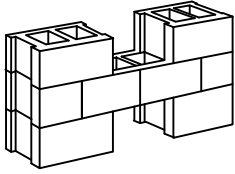

Harvey Cement Products, Inc.

Since 1947

16030 Park Avenue, Harvey, IL 60426

Ph: 708.333.1900 F: 708.333.1910

www.harveycement.com

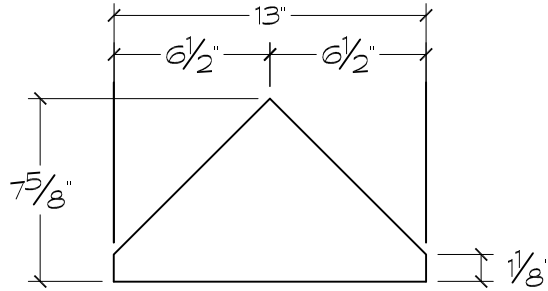

CROSS SECTION

1 PROFILE AM

ARCH REF:
SCALE: 1-1/2"=1'-0"

Profile ID

AM

SUGGESTED USE

Sill	
Transition Band	
Coping	X
Cap	X
Field / Band	
Cornice	

TYPE / SIZE AVAILABILITY

TYPE	LENGTH(S)
Straight	23 5/8"
Left End Return	20"
Right End Return	20"
End Return	23 5/8"

TOP VIEWS

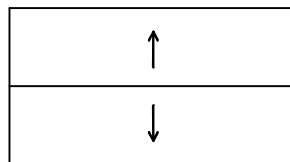

STRAIGHT

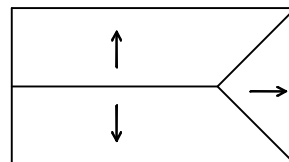

END RETURN

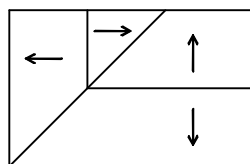

LEFT END RETURN

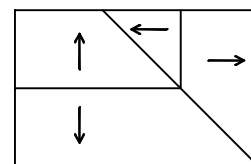

RIGHT END RETURN

DRIP EDGE - OPTIONAL

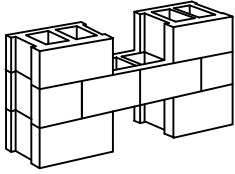

Harvey Cement Products, Inc.

Since 1947

16030 Park Avenue, Harvey, IL 60426

Ph: 708.333.1900 F: 708.333.1910

www.harveycement.com

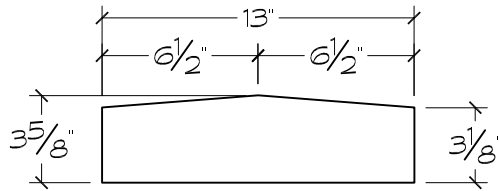

CROSS SECTION

1

PROFILE AR

ARCH REF:

SCALE: 1-1/2"=1'-0"

Profile ID

AR

SUGGESTED USE

Sill	
Transition Band	
Coping	X
Cap	X
Field / Band	
Cornice	

TYPE / SIZE AVAILABILITY

TYPE	LENGTH(S)
Straight	23 5/8"
End Return	24 3/4"

TOP VIEWS

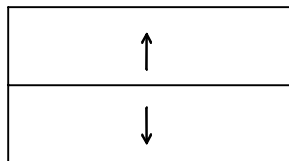

STRAIGHT

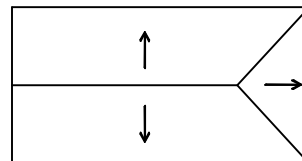

END RETURN

DRIP EDGE - OPTIONAL

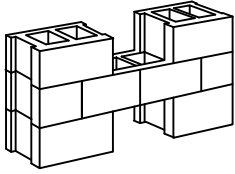

Harvey Cement Products, Inc.

Since 1947

16030 Park Avenue, Harvey, IL 60426

Ph: 708.333.1900 F: 708.333.1910

www.harveycement.com

Profile ID

BD

SUGGESTED USE

Sill	
Transition Band	
Coping	X
Cap	X
Field / Band	
Cornice	

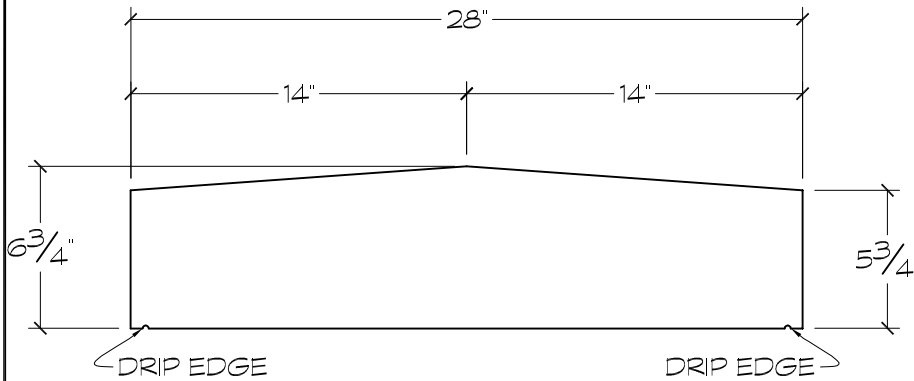

CROSS SECTION

1 PROFILE BD
 ARCH REF:
 SCALE: 1 1/2"=1'-0"

TYPE / SIZE AVAILABILITY

TYPE	LENGTH(S)
Straight	23 5/8"
End Return	14"

TOP VIEWS

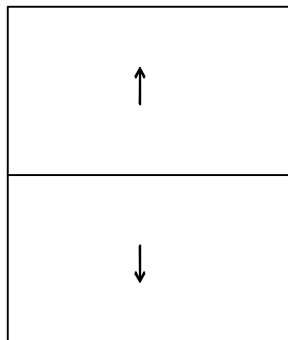

STRAIGHT

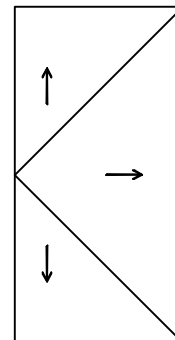

END RETURN

DRIP EDGE - OPTIONAL

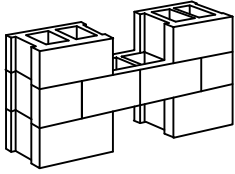

Harvey Cement Products, Inc.

Since 1947

16030 Park Avenue, Harvey, IL 60426

Ph: 708.333.1900 F: 708.333.1910

www.harveycement.com

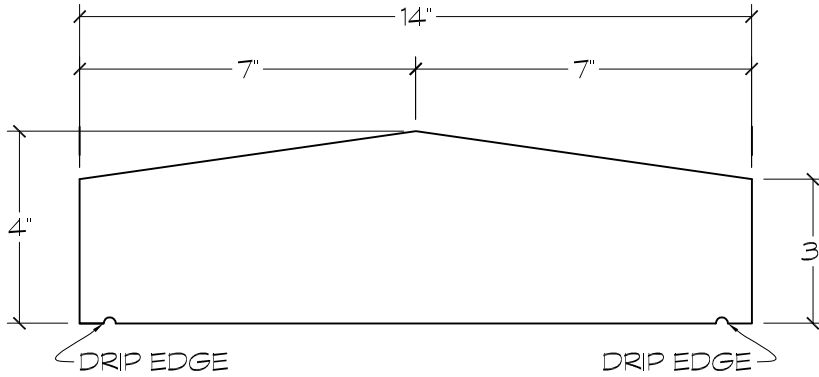

CROSS SECTION

1 **PROFILE CX**

ARCH REF:
SCALE: 3"=1'-0"

Profile ID

CX

SUGGESTED USE

Sill	
Transition Band	
Coping	X
Cap	X
Field / Band	
Cornice	

TYPE / SIZE AVAILABILITY

TYPE	LENGTH(S)
Straight	23 5/8"
Left End Return	24 13/16"
Right End Return	24 13/16"
End Return	24 5/8"

TOP VIEWS

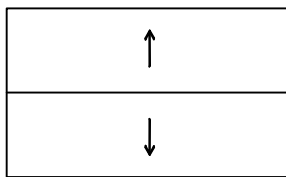

STRAIGHT

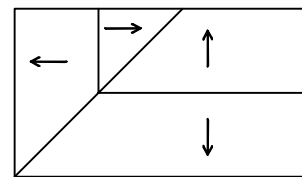

LEFT END RETURN

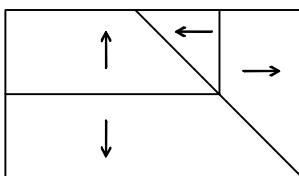

RIGHT END RETURN

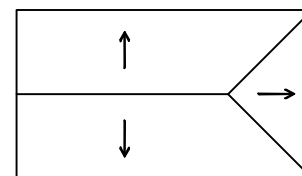

END RETURN

DRIP EDGE - OPTIONAL

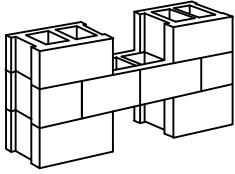

Harvey Cement Products, Inc.

Since 1947

16030 Park Avenue, Harvey, IL 60426

Ph: 708.333.1900 F: 708.333.1910

www.harveycement.com

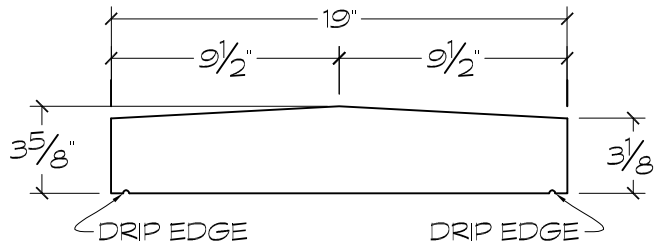

CROSS SECTION

1 **PROFILE DH**
 ARCH REF:
 SCALE: 1-1/2"=1'-0"

Profile ID

DH

SUGGESTED USE

Sill	
Transition Band	
Coping	X
Cap	X
Field / Band	
Cornice	

TYPE / SIZE AVAILABILITY

TYPE	LENGTH(S)
Straight	35 5/8"
Left End Return	35 5/8"
Right End Return	35 5/8"
End Return	35 5/8"

TOP VIEWS

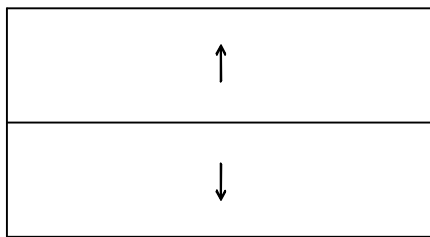

STRAIGHT

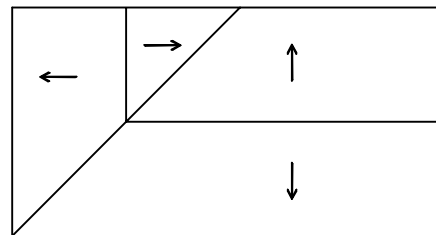

LEFT END RETURN

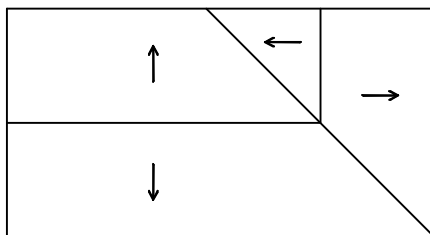

RIGHT END RETURN

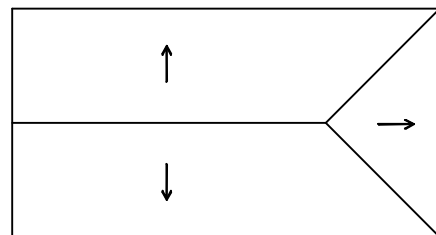

END RETURN

DRIP EDGE - OPTIONAL

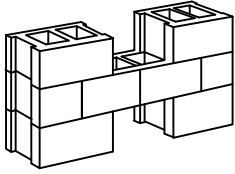

Harvey Cement Products, Inc.

Since 1947

16030 Park Avenue, Harvey, IL 60426

Ph: 708.333.1900 F: 708.333.1910

www.harveycement.com

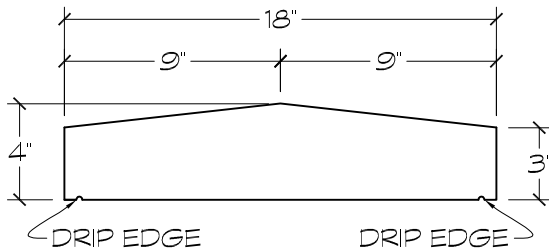

CROSS SECTION

1 **PROFILE DK**

ARCH REF:
SCALE: 1 1/2"=1'-0"

Profile ID

DK

SUGGESTED USE

Sill	
Transition Band	
Coping	X
Cap	X
Field / Band	
Cornice	

TYPE / SIZE AVAILABILITY

TYPE	LENGTH(S)
Straight	23 5/8"
End Return	24 5/8"

TOP VIEWS

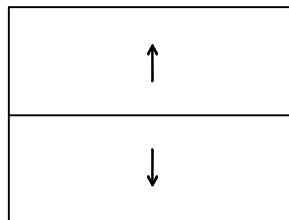

STRAIGHT

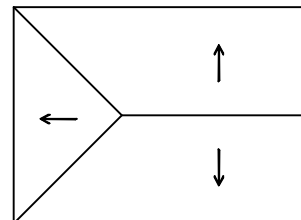

END RETURN

DRIP EDGE - OPTIONAL

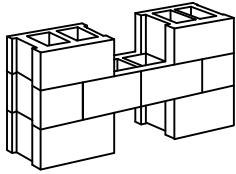

Harvey Cement Products, Inc.

Since 1947

16030 Park Avenue, Harvey, IL 60426

Ph: 708.333.1900 F: 708.333.1910

www.harveycement.com

PROFILE TYPE:

**CHAMFERED
COPING**

SURFACE FINISH:

SMOOTH

REFER TO
INDIVIDUAL
PROFILE (ID) PAGES
FOR DETAILS
AND LENGTHS
AVAILABLE.

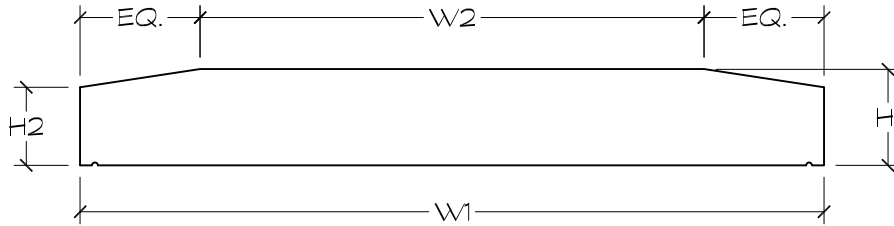

	W1	H1	W2	H2	ID
	10"	3 5/8"	8"	3 1/8"	BT
	12"	3 5/8"	10"	3 1/8"	BL
	14"	3 5/8"	12"	3 1/8"	BQ
	31"	3 5/8"	28"	3 1/8"	DR
	31"	4"	21"	3 1/4"	DB

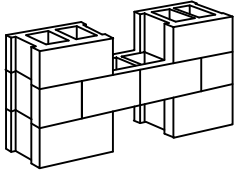

Harvey Cement Products, Inc.

Since 1947

16030 Park Avenue, Harvey, IL 60426

Ph: 708.333.1900 F: 708.333.1910

www.harveycement.com

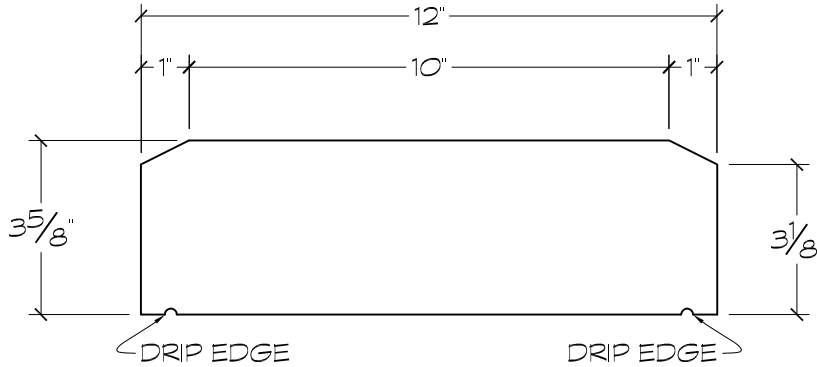

CROSS SECTION

1 PROFILE BL

ARCH REF:
SCALE: 3"=1'-0"

Profile ID

BL

SUGGESTED USE

Sill	
Transition Band	
Coping	X
Cap	X
Field / Band	
Cornice	

TYPE / SIZE AVAILABILITY

TYPE	LENGTH(S)
Straight	Up to 47 5/8"
End Return	20"

TOP VIEWS

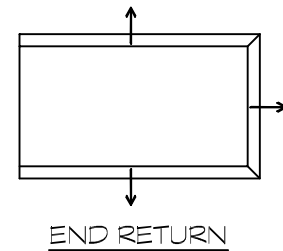
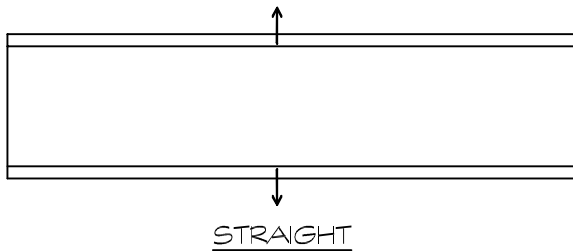

DRIP EDGE - OPTIONAL

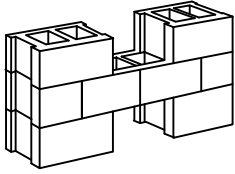

Harvey Cement Products, Inc.

Since 1947

16030 Park Avenue, Harvey, IL 60426

Ph: 708.333.1900 F: 708.333.1910

www.harveycement.com

Profile ID

BQ

SUGGESTED USE

Sill	
Transition Band	
Coping	X
Cap	X
Field / Band	
Cornice	

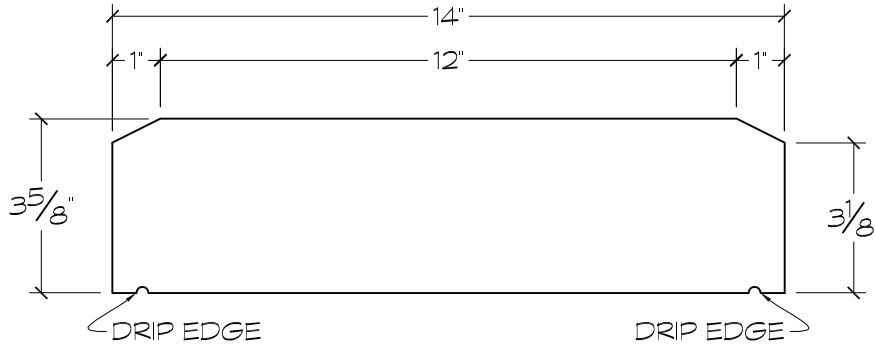

CROSS SECTION

1 **PROFILE BQ**
 ARCH REF:
 SCALE: 3"=1'-0"

TYPE / SIZE AVAILABILITY

TYPE	LENGTH(S)
Straight	Up to 47 5/8"
End Return	Up to 47 5/8"
Right End Return	

TOP VIEWS

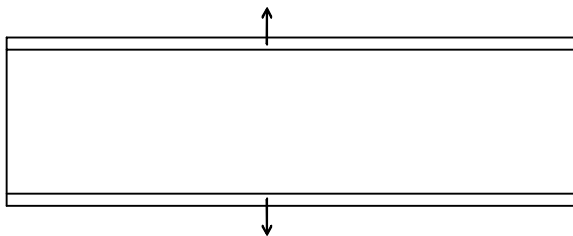

STRAIGHT

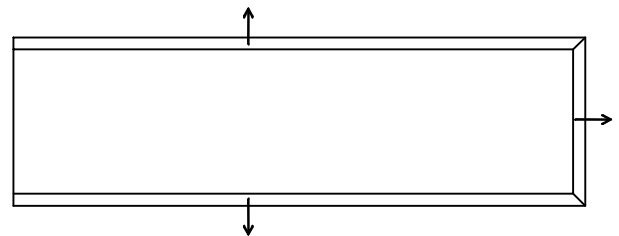

END RETURN

DRIP EDGE - OPTIONAL

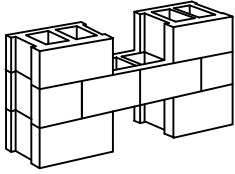

Harvey Cement Products, Inc.

Since 1947

16030 Park Avenue, Harvey, IL 60426

Ph: 708.333.1900 F: 708.333.1910

www.harveycement.com

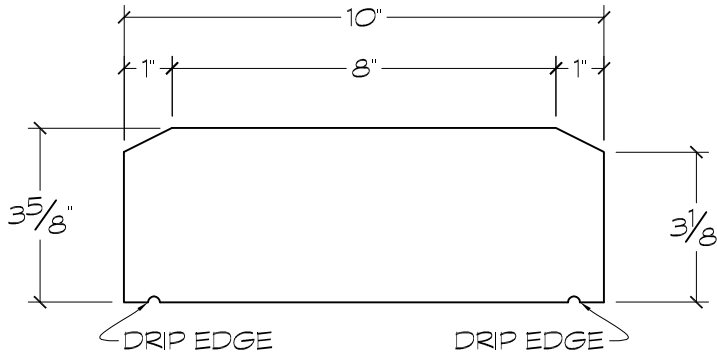

CROSS SECTION

1 PROFILE BT

ARCH REF:
SCALE: 3"=1'-0"

Profile ID

BT

SUGGESTED USE

Sill	
Transition Band	
Coping	X
Cap	X
Field / Band	
Cornice	

TYPE / SIZE AVAILABILITY

TYPE	LENGTH(S)
Straight	Up to 47 5/8"
Left End Return	Up to 47 5/8"
Right End Return	Up to 47 5/8"

TOP VIEWS

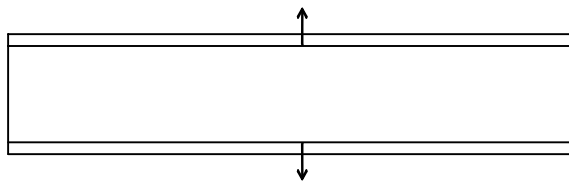

STRAIGHT

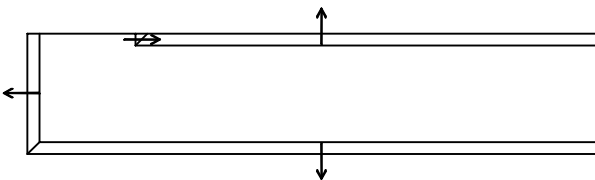

LEFT END RETURN

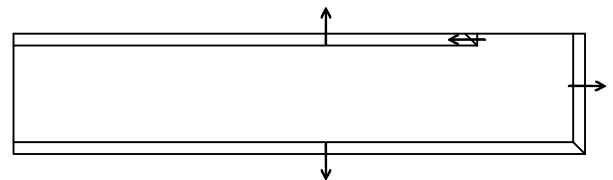

RIGHT END RETURN

DRIP EDGE - OPTIONAL

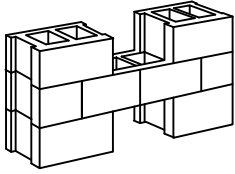

Harvey Cement Products, Inc.

Since 1947

16030 Park Avenue, Harvey, IL 60426

Ph: 708.333.1900 F: 708.333.1910

www.harveycement.com

Profile ID

DB

SUGGESTED USE

Sill	
Transition Band	
Coping	X
Cap	X
Field / Band	
Cornice	

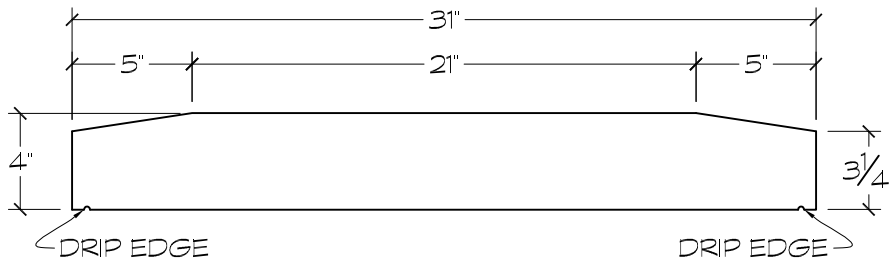

CROSS SECTION

1 **PROFILE DB**

ARCH REF:
SCALE: 1-1/2"=1'-0"

TYPE / SIZE AVAILABILITY

TYPE	LENGTH(S)
Straight	Up to 38"
End Return	Up to 21 3/4"

TOP VIEWS

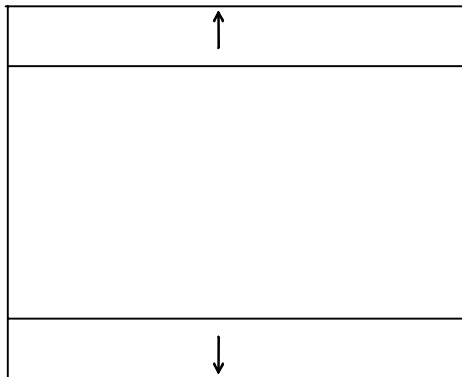

STRAIGHT

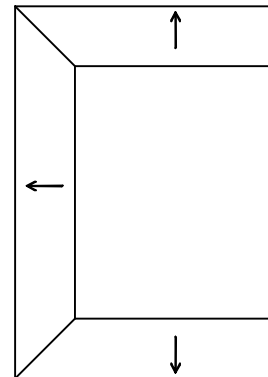

END RETURN

DRIP EDGE - OPTIONAL

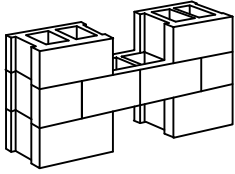

Harvey Cement Products, Inc.

Since 1947

16030 Park Avenue, Harvey, IL 60426

Ph: 708.333.1900 F: 708.333.1910

www.harveycement.com

Profile ID

DR

SUGGESTED USE

Sill	
Transition Band	
Coping	X
Cap	X
Field / Band	
Cornice	

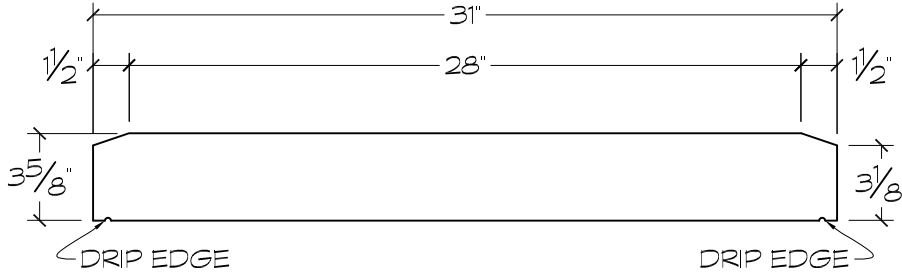

CROSS SECTION

1 **PROFILE DR**
 ARCH REF:
 SCALE: 1 1/2"=1'-0"

TYPE / SIZE
 AVAILABILITY

TYPE	LENGTH(S)
Straight	Up to 25 1/2"
End Return	Up to 25 1/2"

TOP VIEWS

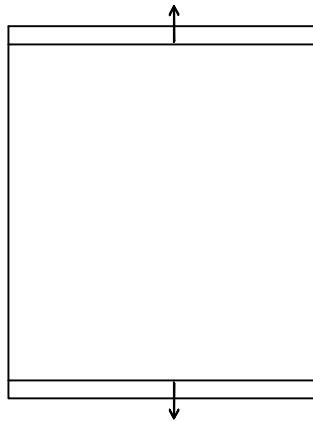

STRAIGHT

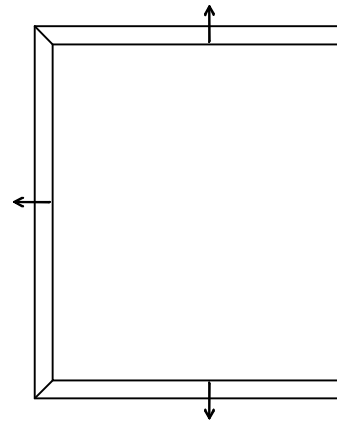

END RETURN

DRIP EDGE - OPTIONAL

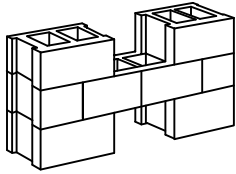

Harvey Cement Products, Inc.

Since 1947

16030 Park Avenue, Harvey, IL 60426

Ph: 708.333.1900 F: 708.333.1910

www.harveycement.com

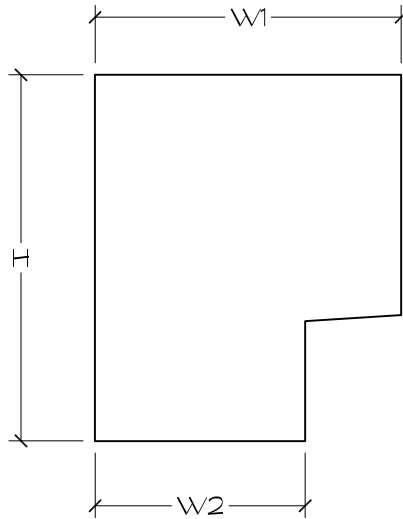

PROFILE TYPE:

CORNICE

SURFACE FINISH:

SMOOTH

REFER TO
INDIVIDUAL
PROFILE (ID) PAGES
FOR DETAILS
AND LENGTHS
AVAILABLE.

	W1	H	W2	ID
	6 ³ / ₈ "	7 ⁵ / ₈ "	4 ³ / ₈ "	X
	6 ⁵ / ₈ "	15 ⁵ / ₈ "	5 ¹ / ₈ "	N
	7 ⁵ / ₈ "	6"	5 ¹ / ₈ "	HW
	9 ⁵ / ₈ "	5 ³ / ₁₆ "	7 ⁵ / ₈ "	BA
	9 ⁵ / ₈ "	5 ⁵ / ₈ "	7 ⁵ / ₈ "	EH
	9 ⁵ / ₈ "	6 ¹ / ₈ "	7 ¹ / ₈ "	HS
	9 ⁵ / ₈ "	7 ³ / ₈ "	7 ¹ / ₈ "	HH
	9 ⁵ / ₈ "	8 ¹ / ₈ "	7 ¹ / ₂ "	HT
	11"	6"	7 ³ / ₄ "	EK

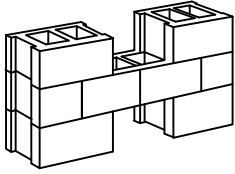

Harvey Cement Products, Inc.

Since 1947

16030 Park Avenue, Harvey, IL 60426

Ph: 708.333.1900 F: 708.333.1910

www.harveycement.com

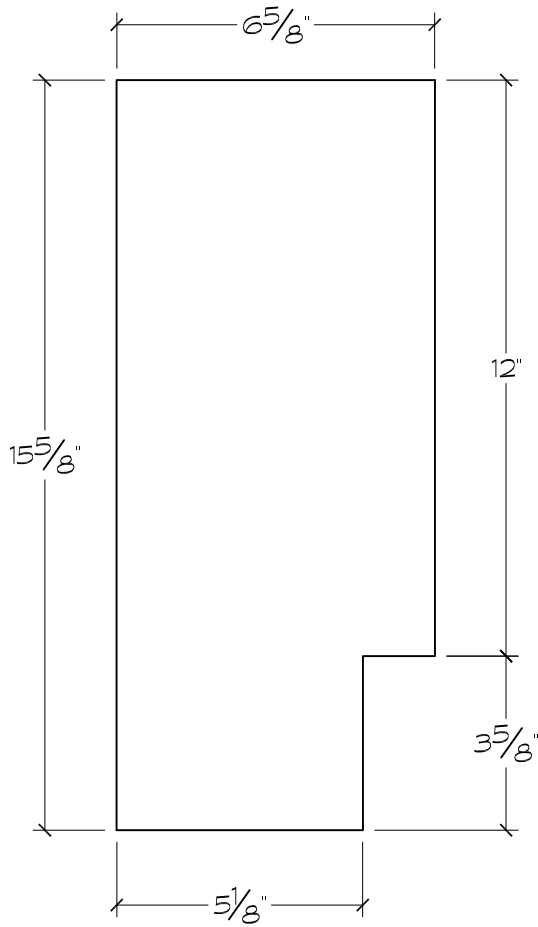

CROSS SECTION

1 **PROFILE N**
 ARCH REF:
 SCALE: 3"=1'-0"

FRONT VIEWS

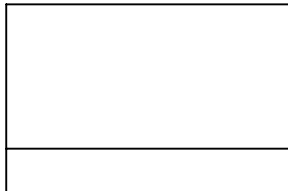

STRAIGHT

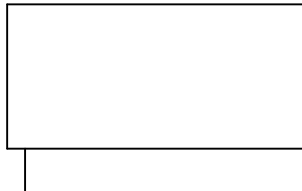

LEFT END RETURN

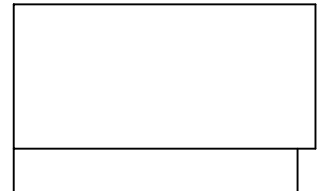

RIGHT END RETURN

DRIP EDGE - OPTIONAL

Profile ID

N

SUGGESTED USE

Sill	
Transition Band	
Coping	
Cap	
Field / Band	X
Cornice	X

**TYPE / SIZE
 AVAILABILITY**

TYPE	LENGTH(S)
Straight	23 5/8"
Left End Return	25 1/8"
Right End Return	25 1/8"

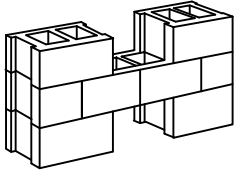

Harvey Cement Products, Inc.

Since 1947

16030 Park Avenue, Harvey, IL 60426

Ph: 708.333.1900 F: 708.333.1910

www.harveycement.com

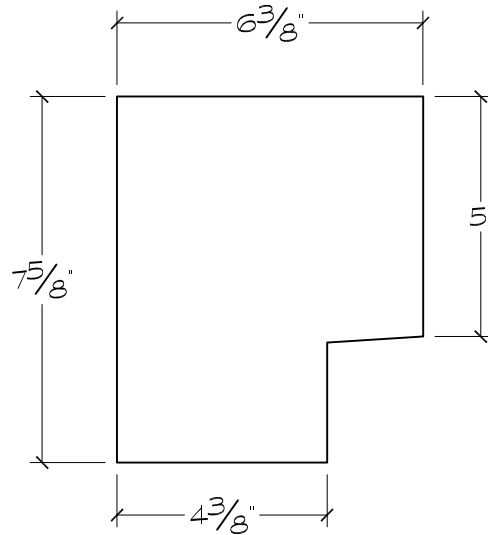

CROSS SECTION

1 **PROFILE X**
 ARCH REF:
 SCALE: 3"=1'-0"

Profile ID

X

SUGGESTED USE

Sill	
Transition Band	
Coping	
Cap	
Field / Band	X
Cornice	X

TYPE / SIZE AVAILABILITY

TYPE	LENGTH(S)
Straight	35 5/8"
Left End Return	Up to 38 3/8"
Right End Return	Up to 38 3/8"

FRONT VIEWS

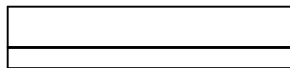

STRAIGHT

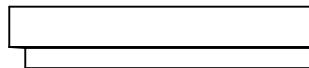

LEFT END RETURN

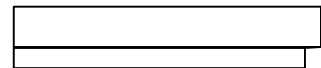

RIGHT END RETURN

DRIP EDGE - OPTIONAL

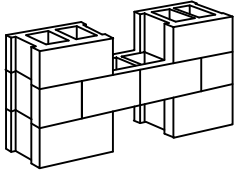

Harvey Cement Products, Inc.

Since 1947

16030 Park Avenue, Harvey, IL 60426

Ph: 708.333.1900 F: 708.333.1910

www.harveycement.com

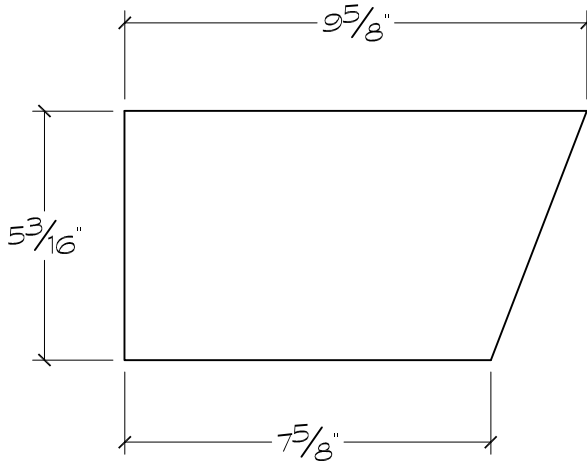

CROSS SECTION

1

PROFILE BA

ARCH REF:
SCALE: 3"=1'-0"

Profile ID

BA

SUGGESTED USE

Sill	
Transition Band	
Coping	
Cap	
Field / Band	X
Cornice	X

**TYPE / SIZE
AVAILABILITY**

TYPE	LENGTH(S)
Straight	23 5/8"
Left End Return	25 13/16"
Right End Return	25 13/16"

TOP VIEWS



STRAIGHT



LEFT END RETURN



RIGHT END RETURN

DRIP EDGE - OPTIONAL

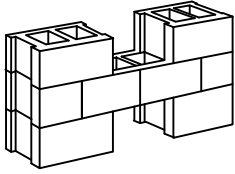

Harvey Cement Products, Inc.

Since 1947

16030 Park Avenue, Harvey, IL 60426

Ph: 708.333.1900 F: 708.333.1910

www.harveycement.com

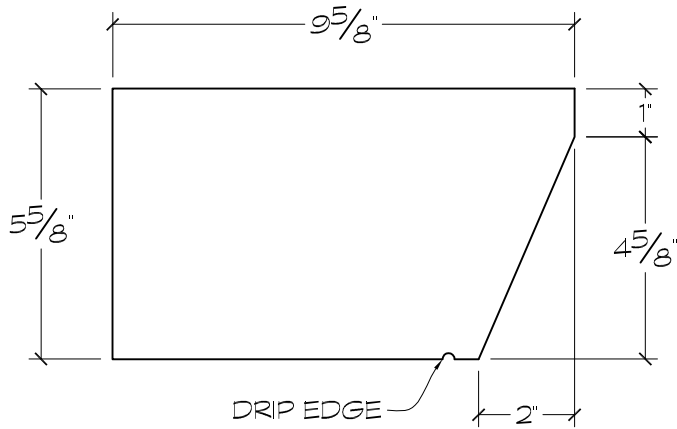

CROSS SECTION

1 **PROFILE EH**
 ARCH REF:
 SCALE: 3"=1'-0"

Profile ID

EH

SUGGESTED USE

Sill	
Transition Band	
Coping	
Cap	
Field / Band	X
Cornice	X

TYPE / SIZE AVAILABILITY

TYPE	LENGTH(S)
Straight	23 5/8"
Left End Return	23 5/8"
Right End Return	23 5/8"

FRONT VIEWS

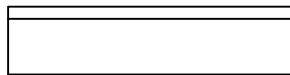

STRAIGHT

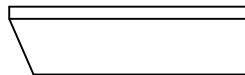

LEFT END RETURN

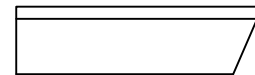

RIGHT END RETURN

DRIP EDGE - OPTIONAL

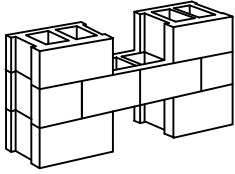

Harvey Cement Products, Inc.

Since 1947

16030 Park Avenue, Harvey, IL 60426

Ph: 708.333.1900 F: 708.333.1910

www.harveycement.com

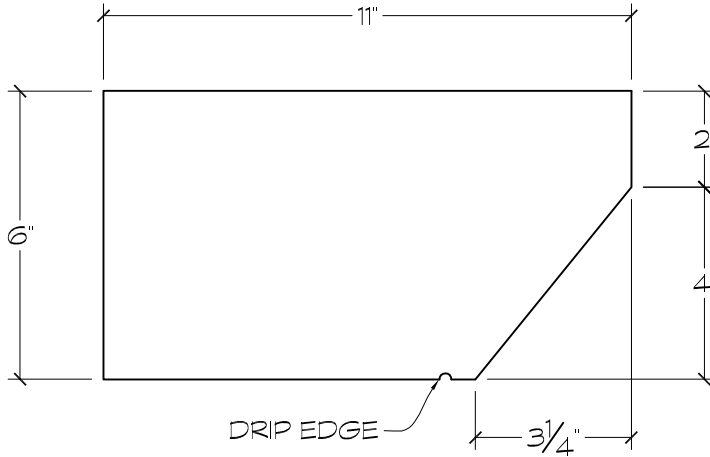

CROSS SECTION

① **PROFILE EK**
 ARCH REF:
 SCALE: 3"=1'-0"

Profile ID

EK

SUGGESTED USE

Sill	
Transition Band	
Coping	
Cap	
Field / Band	X
Cornice	X

TYPE / SIZE AVAILABILITY

TYPE	LENGTH(S)
Straight	23 5/8"
Left End Return	Up to 32 13/16"
Right End Return	Up to 32 13/16"

FRONT VIEWS

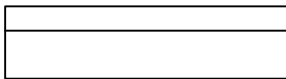

STRAIGHT

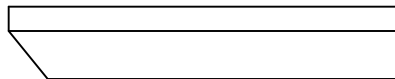

LEFT END RETURN

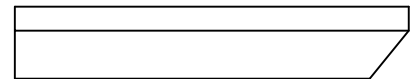

RIGHT END RETURN

DRIP EDGE - OPTIONAL

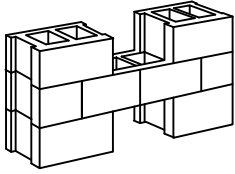

Harvey Cement Products, Inc.

Since 1947

16030 Park Avenue, Harvey, IL 60426

Ph: 708.333.1900 F: 708.333.1910

www.harveycement.com

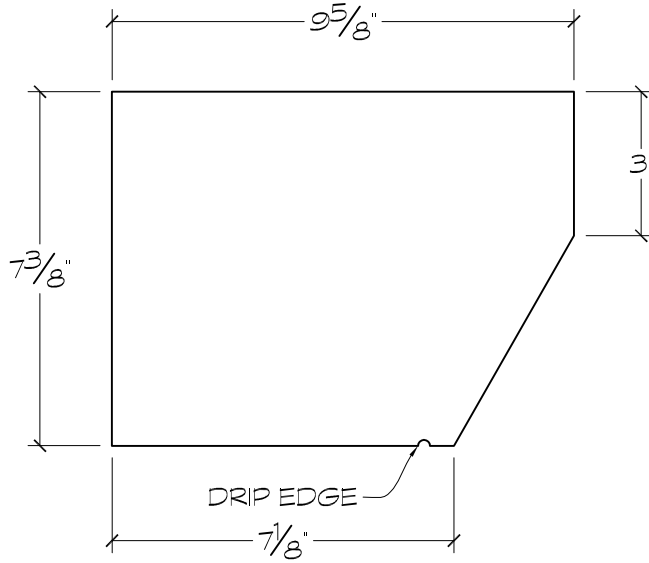

CROSS SECTION

① **PROFILE HH**
 ARCH REF:
 SCALE: 3"=1'-0"

Profile ID

HH

SUGGESTED USE

Sill	
Transition Band	
Coping	
Cap	
Band	X
Cornice	X

TYPE / SIZE AVAILABILITY

TYPE	LENGTH(S)
Straight	Up to 27 7/16"
Left End Return	Up to 34 1/8"
Right End Return	Up to 34 1/8"

FRONT VIEWS

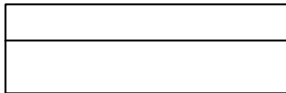

STRAIGHT

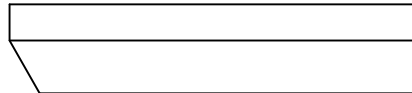

LEFT END RETURN

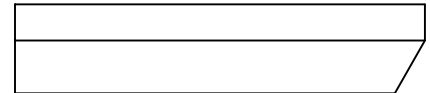

RIGHT END RETURN

DRIP EDGE - OPTIONAL

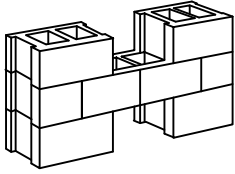

Harvey Cement Products, Inc.

Since 1947

16030 Park Avenue, Harvey, IL 60426

Ph: 708.333.1900 F: 708.333.1910

www.harveycement.com

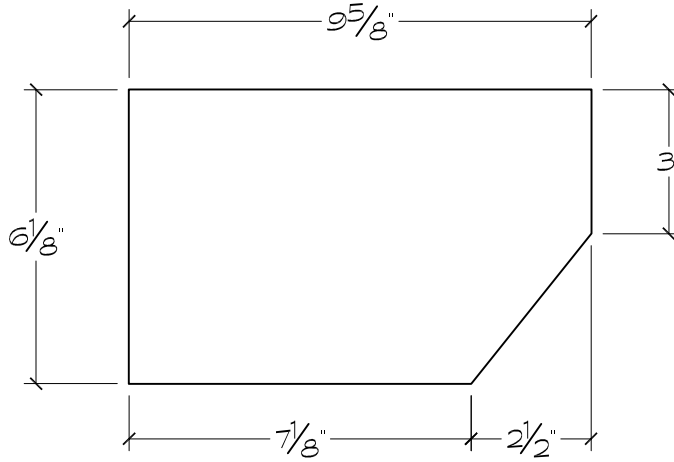

CROSS SECTION

1

PROFILE HS

ARCH REF:
SCALE: 3"=1'-0"

FRONT VIEWS

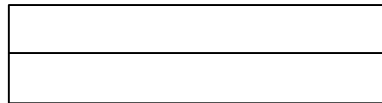

STRAIGHT



LEFT END RETURN

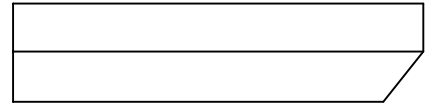

RIGHT END RETURN

DRIP EDGE - OPTIONAL

Profile ID

HS

SUGGESTED USE

Sill	
Transition Band	
Coping	
Cap	
Band	
Field	
Cornice	x

**TYPE / SIZE
AVAILABILITY**

TYPE	LENGTH(S)
Straight	23 5/8"
Left End Return	25 5/8"
Right End Return	25 5/8"



Harvey Cement Products, Inc.

Since 1947

16030 Park Avenue, Harvey, IL 60426

Ph: 708.333.1900 F: 708.333.1910

www.harveycement.com

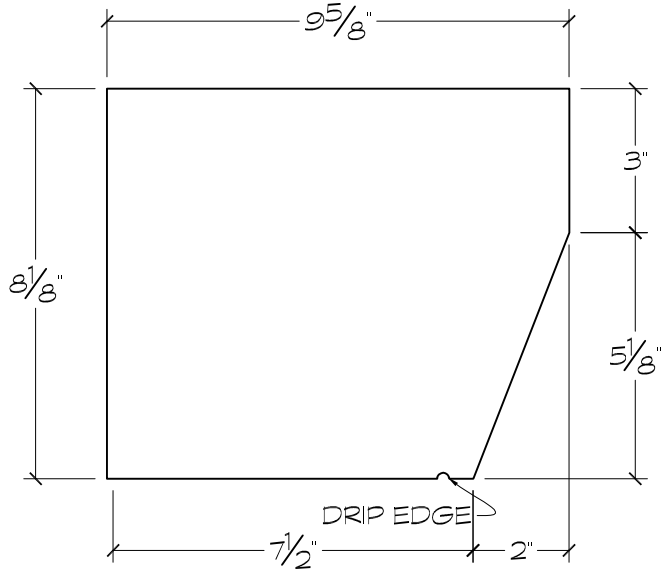

CROSS SECTION

1 **PROFILE HT**
 ARCH REF:
 SCALE: 3"=1'-0"

FRONT VIEWS

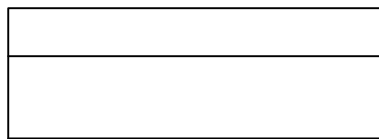

STRAIGHT

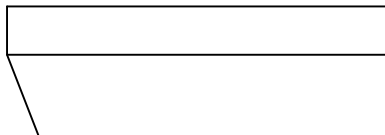

LEFT END RETURN

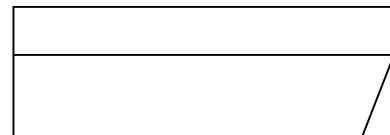

RIGHT END RETURN

DRIP EDGE - OPTIONAL

Profile ID

HT

SUGGESTED USE

Sill	
Transition Band	
Coping	
Cap	
Band	
Field	
Cornice	X

TYPE / SIZE AVAILABILITY

TYPE	LENGTH(S)
Straight	23 5/8"
Left End Return	23 3/4"
Right End Return	23 3/4"

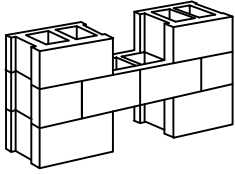

Harvey Cement Products, Inc.

Since 1947

16030 Park Avenue, Harvey, IL 60426

Ph: 708.333.1900 F: 708.333.1910

www.harveycement.com

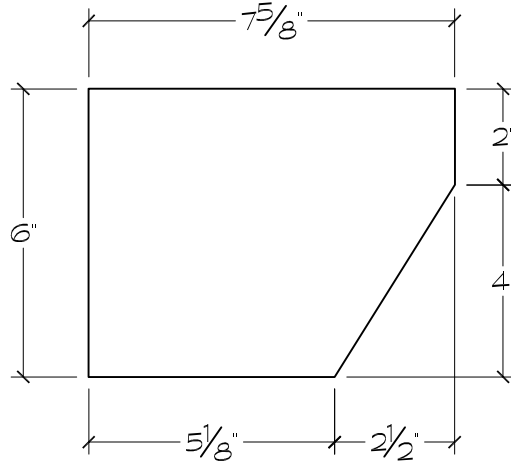

CROSS SECTION

1 **PROFILE HW**

ARCH REF:
SCALE: 3"=1'-0"

FRONT VIEWS

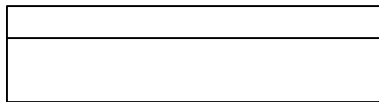

STRAIGHT

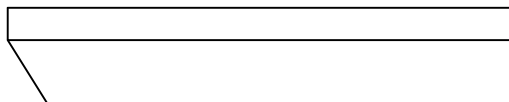

LEFT END RETURN

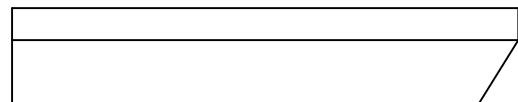

RIGHT END RETURN

DRIP EDGE - OPTIONAL

Profile ID

HW

SUGGESTED USE

Sill	
Transition Band	
Coping	
Cap	
Band	
Field	
Cornice	X

**TYPE / SIZE
AVAILABILITY**

TYPE	LENGTH(S)
Straight	23 ⁵ / ₈ "
Left End Return	Up to 31 ⁵ / ₈ "
Right End Return	Up to 31 ⁵ / ₈ "

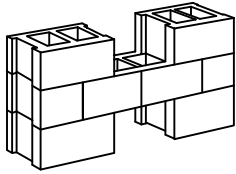

Harvey Cement Products, Inc.

Since 1947

16030 Park Avenue, Harvey, IL 60426

Ph: 708.333.1900 F: 708.333.1910

www.harveycement.com

PROFILE SHAPES DIFFER
FOR EACH PROFILE. SEE
TABLE BELOW.

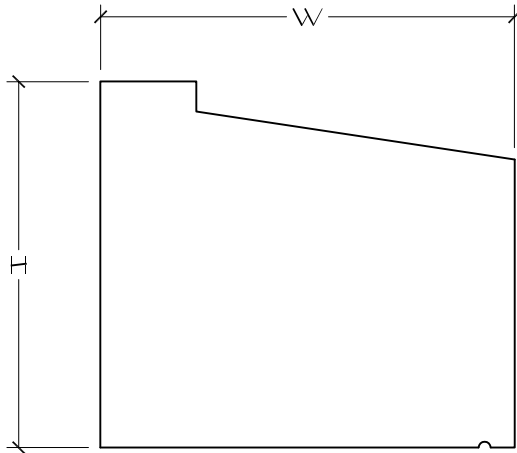

PROFILE TYPE:

SPECIALTY

SURFACE FINISH:

SMOOTH

REFER TO
INDIVIDUAL
PROFILE (ID) PAGES
FOR DETAILS
AND LENGTHS
AVAILABLE.

	W	H	ID	COMMENTS
	3 5/8"	2 3/8"	CM	Cast Stone "Brick"
	4 3/4"	2 1/4"	AG	Bullnose
	5 1/2"	4 5/8"	HL	Cap
	5 5/8"	7 1/2"	GN	Stepped Band
	6 1/2"	7 5/8"	EC	Cap
	8 5/8"	2 3/4"	AS	Cap
	8 5/8"	7 5/8"	CY	Cap
	12"	3 3/4"	CK	Square Cap
	12"	5 1/4"	AL	Coping/Cap
	22"	4 1/2"	DP	Stepped Cap

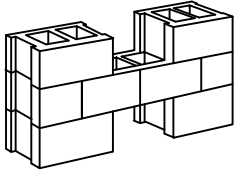

Harvey Cement Products, Inc.

Since 1947

16030 Park Avenue, Harvey, IL 60426

Ph: 708.333.1900 F: 708.333.1910

www.harveycement.com

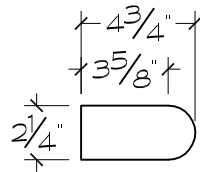

CROSS SECTION

① **PROFILE AG**

ARCH REF:
SCALE: 1-1/2"=1'-0"

Profile ID

AG

SUGGESTED USE

Sill	×
Transition Band	×
Coping	
Cap	
Field / Band	×
Cornice	

TYPE / SIZE AVAILABILITY

TYPE	LENGTH(S)
Straight	Up to 35 5/8"
Left End Return	Up to 35 5/8"
Right End Return	Up to 35 5/8"

FRONT VIEWS

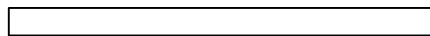

STRAIGHT

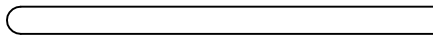

LEFT END RETURN

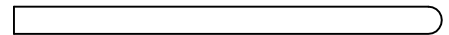

RIGHT END RETURN

DRIP EDGE - OPTIONAL

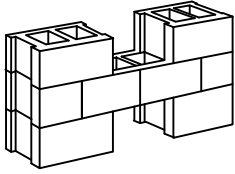

Harvey Cement Products, Inc.

Since 1947

16030 Park Avenue, Harvey, IL 60426

Ph: 708.333.1900 F: 708.333.1910

www.harveycement.com

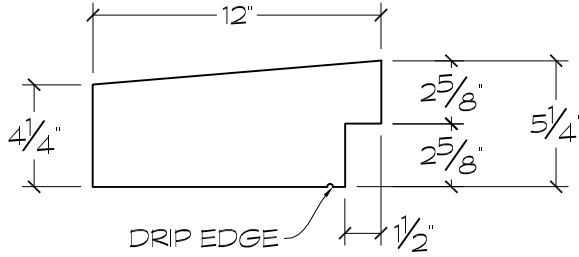

CROSS SECTION

① **PROFILE AL**
 ARCH REF:
 SCALE: 1-1/2"=1'-0"

Profile ID

AL

SUGGESTED USE

Sill	
Transition Band	
Coping	X
Cap	X
Field / Band	
Cornice	

TYPE / SIZE AVAILABILITY

TYPE	LENGTH(S)
Straight	Up to 35 5/8"
Left End Return	Up to 35 5/8"
Right End Return	Up to 35 5/8"

TOP VIEWS

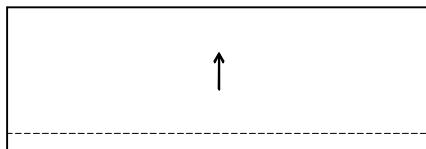

STRAIGHT

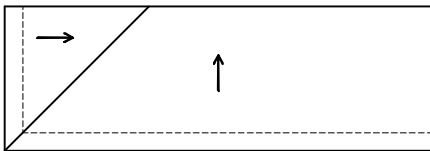

LEFT END RETURN

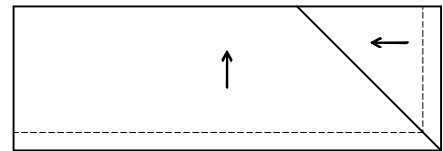

RIGHT END RETURN

DRIP EDGE - OPTIONAL

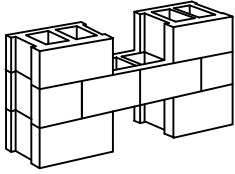

Harvey Cement Products, Inc.

Since 1947

16030 Park Avenue, Harvey, IL 60426

Ph: 708.333.1900 F: 708.333.1910

www.harveycement.com

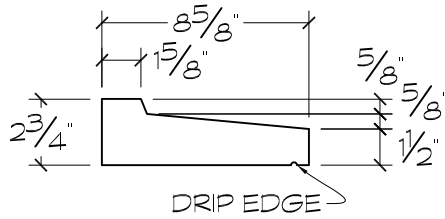

CROSS SECTION

1 PROFILE AS
 ARCH REF:
 SCALE: 1-1/2"=1'-0"

Profile ID

AS

SUGGESTED USE

Sill	
Transition Band	
Coping	
Cap	X
Field / Band	
Cornice	

TYPE / SIZE AVAILABILITY

TYPE	LENGTH(S)
Straight	23 5/8"
Left End Return	25 1/8"
Right End Return	25 1/8"

TOP VIEWS

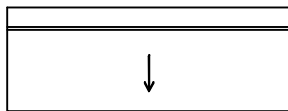

STRAIGHT

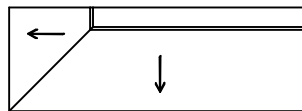

LEFT END RETURN

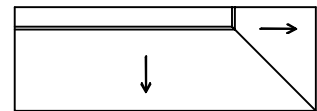

RIGHT END RETURN

DRIP EDGE - OPTIONAL

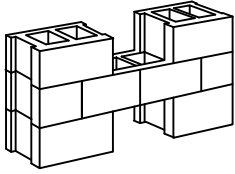

Harvey Cement Products, Inc.

Since 1947

16030 Park Avenue, Harvey, IL 60426

Ph: 708.333.1900 F: 708.333.1910

www.harveycement.com

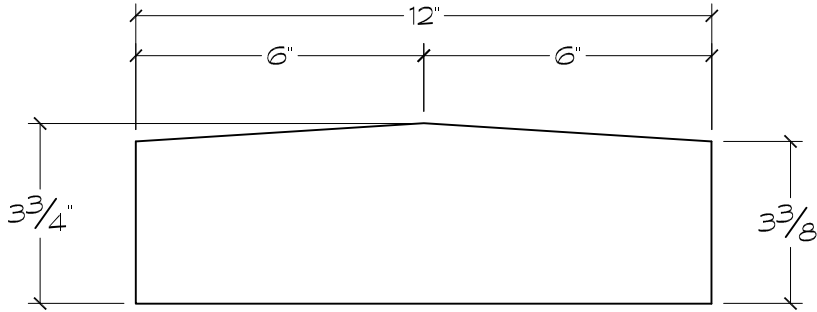

CROSS SECTION

① **PROFILE CK**
 ARCH REF:
 SCALE: 3"=1'-0"

TOP VIEW

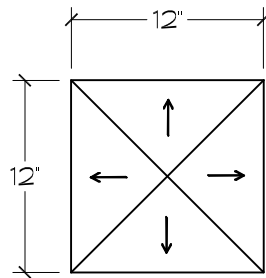

DRIP EDGE - OPTIONAL

Profile ID

CK

SUGGESTED USE

Sill	
Transition Band	
Coping	
Cap	X
Field / Band	
Cornice	

**TYPE / SIZE
 AVAILABILITY**

TYPE	LENGTH(S)
Cap	12"

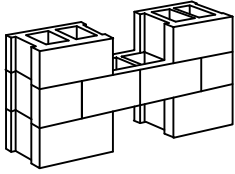

Harvey Cement Products, Inc.

Since 1947

16030 Park Avenue, Harvey, IL 60426

Ph: 708.333.1900 F: 708.333.1910

www.harveycement.com

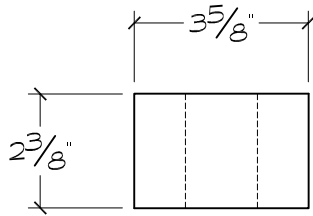

CROSS SECTION

1 **PROFILE CM**
 ARCH REF:
 SCALE: 3"=1'-0"

TOP VIEW

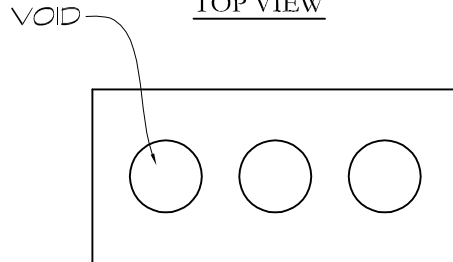

Profile ID

CM

SUGGESTED USE

Sill	
Transition Band	
Coping	
Cap	
Field / Band	X
Cornice	

**TYPE / SIZE
 AVAILABILITY**

TYPE	LENGTH(S)
Straight	7 5/8"

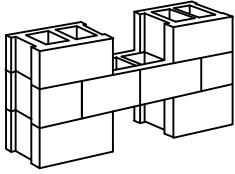

Harvey Cement Products, Inc.

Since 1947

16030 Park Avenue, Harvey, IL 60426

Ph: 708.333.1900 F: 708.333.1910

www.harveycement.com

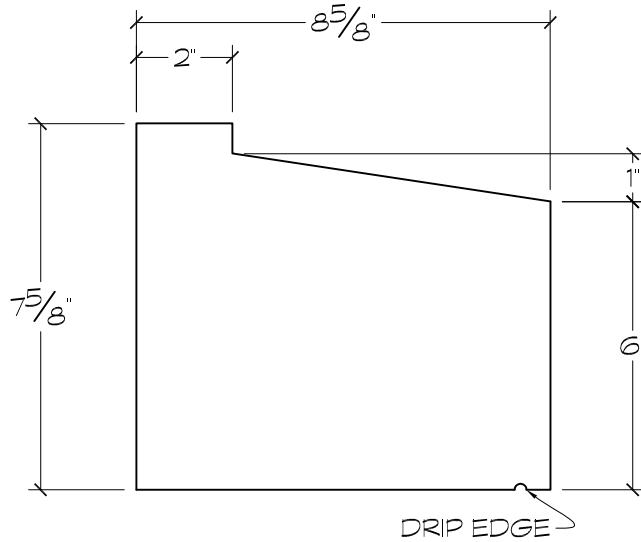

CROSS SECTION

① **PROFILE CY**
 ARCH REF:
 SCALE: 3"=1'-0"

Profile ID

CY

SUGGESTED USE

Sill	
Transition Band	
Coping	
Cap	X
Field / Band	
Cornice	

TYPE / SIZE AVAILABILITY

TYPE	LENGTH(S)
Straight	23 5/8"
Left End Return	25 1/2"
Right End Return	25 1/2"

TOP VIEWS

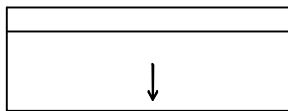

STRAIGHT

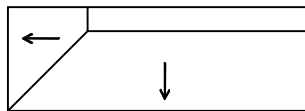

LEFT END RETURN

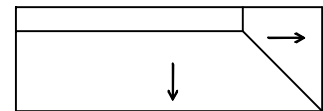

RIGHT END RETURN

DRIP EDGE - OPTIONAL

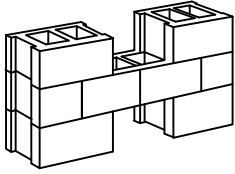

Harvey Cement Products, Inc.

Since 1947

16030 Park Avenue, Harvey, IL 60426

Ph: 708.333.1900 F: 708.333.1910

www.harveycement.com

TOP VIEW

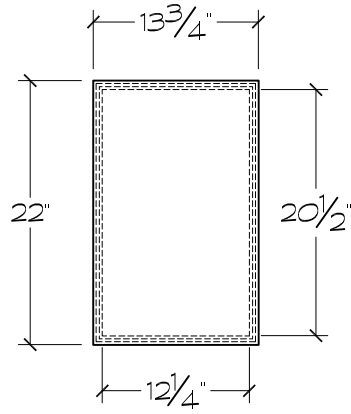

CAP

Profile ID

DP

SUGGESTED USE

Sill	
Transition Band	
Coping	
Cap	X
Field / Band	
Cornice	

TYPE / SIZE AVAILABILITY

TYPE	LENGTH(S)
Cap	13 3/4"

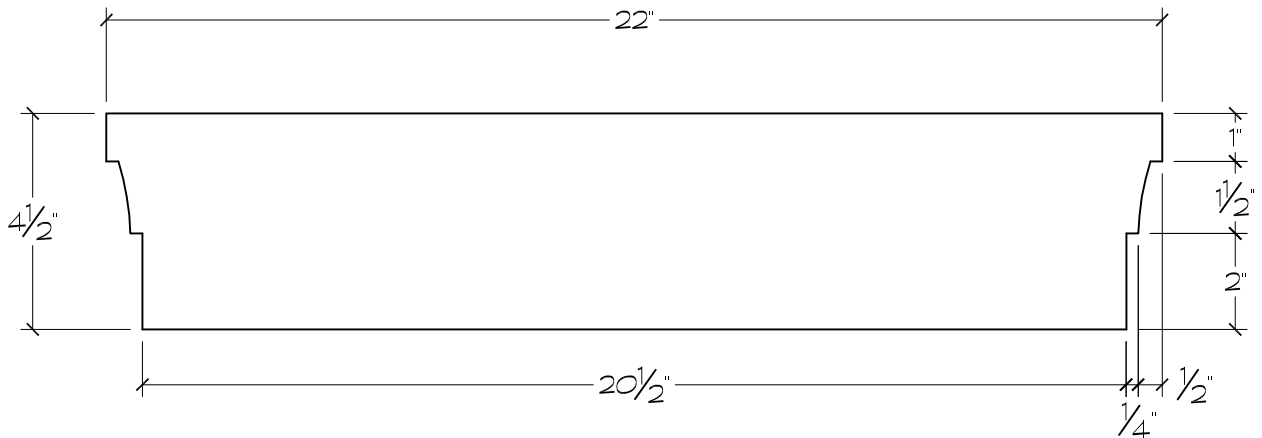

CROSS SECTION

1 **PROFILE DP**
 ARCH REF:
 SCALE: 3"=1'-0"

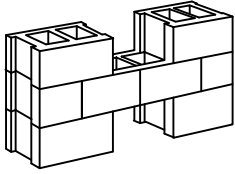

Harvey Cement Products, Inc.

Since 1947

16030 Park Avenue, Harvey, IL 60426

Ph: 708.333.1900 F: 708.333.1910

www.harveycement.com

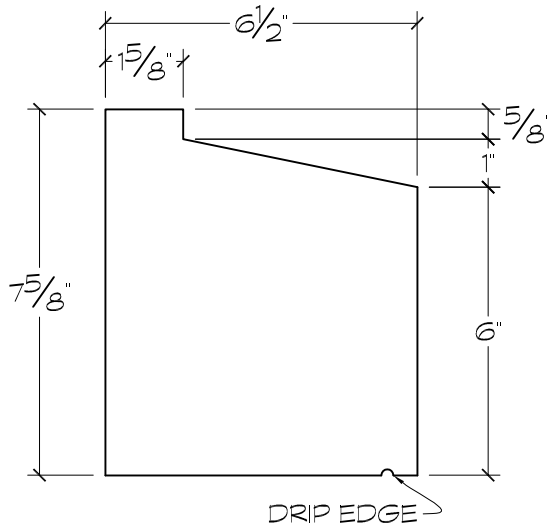

CROSS SECTION

1 **PROFILE EC**

ARCH REF:
SCALE: 3"=1'-0"

TOP VIEWS

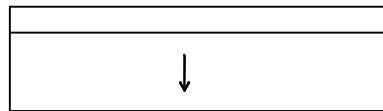

STRAIGHT

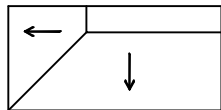

LEFT END RETURN

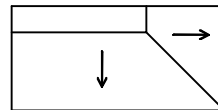

RIGHT END RETURN

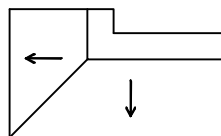

CUSTOM LEFT RETURN

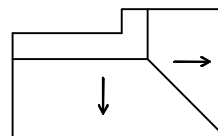

CUSTOM RIGHT RETURN

DRIP EDGE - OPTIONAL

Profile ID

EC

SUGGESTED USE

Sill	
Transition Band	X
Coping	
Cap	X
Band	
Field	

TYPE / SIZE
AVAILABILITY

TYPE	LENGTH(S)
Straight	23 ⁵ / ₈ "
Left End Return	Up to 23 ⁵ / ₈ "
Right End Return	Up to 23 ⁵ / ₈ "
Custom Left Ret.	Up to 23 ⁵ / ₈ "
Custom Right Ret.	Up to 23 ⁵ / ₈ "

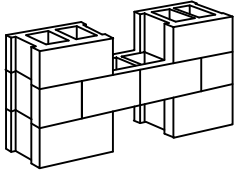

Harvey Cement Products, Inc.

Since 1947

16030 Park Avenue, Harvey, IL 60426

Ph: 708.333.1900 F: 708.333.1910

www.harveycement.com

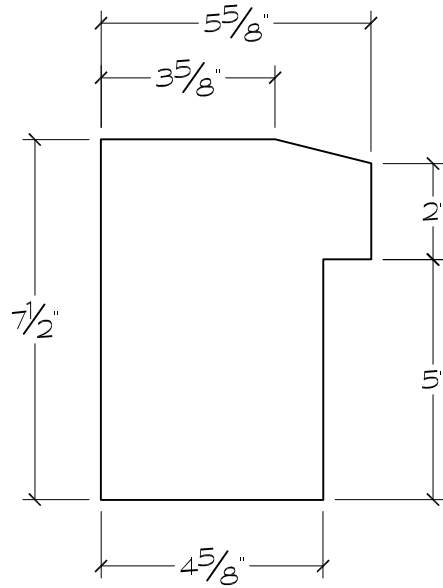

CROSS SECTION

1 **PROFILE GN**
 ARCH REF:
 SCALE: 3"=1'-0"

Profile ID

GN

SUGGESTED USE

Sill	
Transition Band	
Coping	
Cap	
Field / Band	X
Cornice	

TYPE / SIZE AVAILABILITY

TYPE	LENGTH(S)
Straight	35 5/8"
Left End Return	35 5/8"
Right End Return	35 5/8"

TOP VIEWS

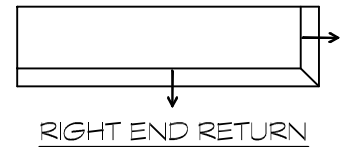
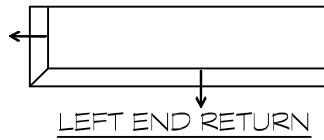
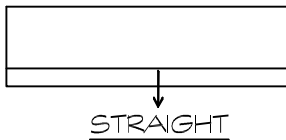

DRIP EDGE - OPTIONAL

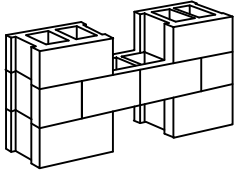

Harvey Cement Products, Inc.

Since 1947

16030 Park Avenue, Harvey, IL 60426

Ph: 708.333.1900 F: 708.333.1910

www.harveycement.com

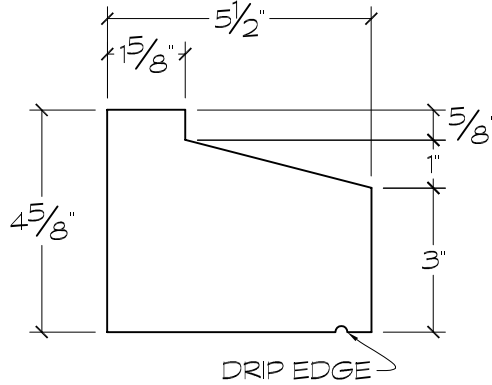

CROSS SECTION

1 **PROFILE HL**
 ARCH REF:
 SCALE: 3"=1'-0"

TOP VIEWS

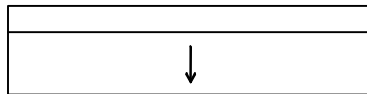

STRAIGHT

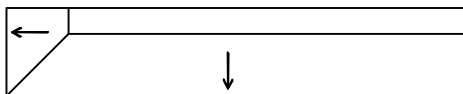

LEFT END RETURN

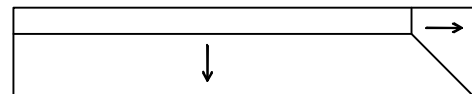

RIGHT END RETURN

DRIP EDGE - OPTIONAL

Profile ID

HL

SUGGESTED USE

Sill	X
Transition Band	X
Coping	
Cap	X
Band	
Cornice	

TYPE / SIZE AVAILABILITY

TYPE	LENGTH(S)
Standard Straight	23 5/8"
Straight	Up to 25 5/8"
Left End Return	Up to 28 3/4"
Right End Return	Up to 28 3/4"